

PURE
COLLECTION



ctesi
we are waterproof



+ 20 years dedicated to the sanitary ware sector. We are a group that provides a wide range of bathroom and plumbing integrated options.

+ 20 ans dédiés au secteur des articles sanitaires. Nous sommes un groupe qui vous propose une large gamme d'options intégrées de salles de bains et de plomberie.

+ de 20 años dedicándonos al sector de artículos sanitarios. Somos un grupo que proporciona a nuestros clientes una amplia gama de opciones integradas para baños y sistemas de plomería.

Technology has greatly evolved and so have the materials and our way of living. But our commitment remains just the same: To provide a premium service that mixes the product's quality, elegance, functionality and design through our Portuguese brand - Ctesi.

La technologie a évolué, le type de matériaux a également changé, ainsi que notre façon de vivre. Mais notre engagement reste toujours le même: fournir un service d'excellence en combinant la qualité, l'élégance, la fonctionnalité et le design du produit à travers la marque Portugaise Ctesi.

La tecnología ha evolucionado, así cómo y el tipo de materiales y nuestra forma de vivir. Pero nuestro compromiso sigue siendo el mismo: Proporcionar un servicio de excelencia que combina la elegancia, la funcionalidad y el diseño del producto a través de la marca Portuguesa Ctesi.

ctesi
we are waterproof

Ctesi is one of the main sanitary ware sector's references. By investing in the product's design, development and self-production we were able to develop a system where we have total control over the entire process, allowing us to add value to each production stage. Goals: To create competitive products with high quality standards and a modern and functional design. The group's 4 industrial units are different but complement each other and work together through a close partnership. BMwood is responsible for developing bathroom furniture, BMglass develops and produces glass products, BMmetal is an expert in mechanical turning and BMplast works in the thermoplastics' injection. We have the ability to produce a wide range of standard products or customized projects, developed based on the client's needs and according to the strictest quality standards. Our team of more than 150 professionals continues this legacy and prints innovation, technology and new dynamics in each challenge that we face!

"Success is a consequence and must not be a goal."

Gustave Flaubert

Ctesi est l'une des principales références du secteur des articles sanitaires grâce à son investissement dans la conception, le développement et la production de nos propres articles. Nous avons développé un système où nous avons un contrôle total sur l'ensemble du processus, ce qui nous permet d'ajouter une valeur qualitative à chaque étape de la production. Objectifs: Créer des produits compétitifs avec les plus hauts standards de qualité et un design moderne et fonctionnel. Les 4 unités industrielles du groupe sont différentes mais elles se complètent et travaillent ensemble dans une collaboration directe. BMwood est l'unité responsable du développement des meubles de salle de bains, BMglass développe et produit des produits en verre, BMmetal est l'expert du tournage mécanique et BMplast travaille dans l'injection de thermoplastiques. Nous sommes capables de produire une large gamme de produits standards ou des projets personnalisés, développés en fonction des besoins du client, toujours selon les normes de qualité les plus strictes. Notre équipe de plus de 150 professionnels perpétue cet héritage et imprime de l'innovation, de la technologie et une nouvelle dynamique dans chaque défi auquel ils sont confrontés!

"Le succès est une conséquence et non un but."

Gustave Flaubert

















Ctesi es una de las principales referencias del sector de artículos sanitarios gracias a la inversión en el diseño, en el desarrollo y producción de artículos propios. Hemos desarrollado un sistema donde tenemos control sobre todo el proceso, agregando valor cualitativo a cada etapa de la producción. Objetivos: Crear productos competitivos con altos estándares de calidad, diseño moderno y, sobre todo, funcional. Las 4 unidades industriales del grupo son distintas, pero complementarias entre todas, trabajando en colaboración directa. Los muebles de baño son desarrollados por BMwood, los productos en vidrio son desarrollados y producidos por BMglass, BMmetal es la especialista en torneado mecánico y BMplast en la inyección de termoplásticos. Tenemos la capacidad de producir una amplia gama de productos estándar o trabajar en proyectos personalizados, desarrollados de acuerdo con las necesidades del cliente y siempre cumpliendo con los más rigurosos estándares de calidad. ¡Nuestro equipo de más de 150 profesionales continúa este legado e imprime innovación, tecnología y nuevas dinámicas en cada desafío que se le propone!

"El éxito es una consecuencia, no un objetivo."















Gustave Flaubert

ICONOGRAPHY | ICONOGRAPHIE | ICONOGRAFÍA

BATHROOM FURNITURE MEUBLES DE SALLE DE BAIN MUEBLES DE BAÑO

-  **SUSPENDED BASE UNIT**
MEUBLE SUSPENDU
MUEBLE SUSPENDIDO
-  **BASE UNIT WITH FEET**
MEUBLE AVEC PIEDS
MUEBLE CON PATAS
-  **HINGE WITH DAMPING**
CHARNIÈRE AVEC AMORTISSEMENT
BISAGRA CON AMORTIGUACIÓN
-  **SOFT-CLOSE DRAWER SYSTEM**
TIROIR AVEC SYSTÈME SOFT-CLOSE
CAJÓN CON CIERRE SUAVE
-  **CLICK-OPENING DRAWER SYSTEM**
TIROIR AVEC SYSTÈME D'OUVERTURE CLICK
CAJÓN CON APERTURA CLICK
-  **WIDTH**
LARGEUR
ANCHO
-  **DEPTH**
PROFONDEUR
PROFUNDIDAD
-  **HEIGHT**
HAUTEUR
ALTURA
-  **CE COMPLAIN DIRECTIVES**
CONFORMÈMENT AUX DIRECTIVES CE
DECLARACIÓN CE DE CONFORMIDAD
-  **ENERGY-SAVING LAMP**
LAMPE ÉCONOMISEUSE D'ÉNERGIE
LÁMPARA ECONOMIZADORA
-  **LEDS STRIPES**
BANDE LEDS
TIRA DE LEDS
-  **IP DEGREE PROTECTION**
INDICE DE PROTECTION IP
FACTOR DE PROTECCIÓN
-  **EFFICIENT MODEL**
MODÈLE EFFICIENT
MODELO EFICIENTE
-  **LIGHT ORIENTATION**
DIRECTION DE LA LUMIÈRE
DIRECCIÓN DE LA LUZ
-  **ENERGY EFFICIENCY CLASS (I, II, III)**
CLASSE D'EFFICACITÉ ÉNERGÉTIQUE (I, II, III)
CLASE DE EFICIENCIA ENERGÉTICA (I, II, III)
-  **BASE UNIT DEPTH**
PROFONDEUR DU MEUBLE
PROFUNDIDAD DEL MUEBLE



SHOWER ENCLOSURES CABINES DE DOUCHE MAMPARAS DE DUCHA

-  **GLASS**
VERRE
VIDRIO
-  **TRANSPARENT GLASS**
VERRE TRANSPARENT
VIDRIO TRANSPARENTE
-  **FROSTED GLASS**
VERRE DÉPOLI
VIDRIO FOSCO
-  **SERIGRAPHED GLASS - STRIPES**
VERRE SÉRIGRAPHIÉ - RAYURES
VIDRIO SERIGRAFADO - RAYAS
-  **BLACK SERIGRAPHED GLASS - SQUARE**
VERRE NOIR SÉRIGRAPHIÉ - CARRÉ
VIDRIO NEGRO SERIGRAFADO - CUADRADO
-  **SQUARE SHOWER TRAY**
RECEVEUR DE DOUCHE CARRÉ
PLATO DE DUCHA CUADRADO
-  **RECTANGULAR SHOWER TRAY**
RECEVEUR DE DUCHE RECTANGULAIRE
PLATO DE DUCHA RECTANGULAR
-  **CURVED QUADRANT SHOWER TRAY**
RECEVEUR DE DOUCHE ROND
PLATO DE DUCHA CIRCULAR
-  **RIGHT**
À LA DROITE
A LA DERECHA
-  **LEFT**
À LA GAUCHE
A LA IZQUIERDA
-  **MAGNETIC CLOSING**
FERMETURE MAGNÉTIQUE
CIERRE MAGNÉTICO
-  **REVERSIBLE**
RÉVERSIBLE
REVERSIBLE
-  **FIXED SHOWER**
DOUCHE FIXE
ROCIADOR FIJO
-  **SIDE MASSAGE JETS**
JETS LATÉRAUX
CHORROS LATERALES
-  **HANDSHOWER**
DOUCHE À MAINS
DUCHA DE MANO
-  **SINGLE LEVER MIXER**
MITIGEUR
MONOMANDO
-  **MOUNTING RODS INCLUDED**
TIGES DE FIXATION INCLUSES
VARILLAS DE FIXACIÓN INCLUIDAS
-  **ACRYLIC**
ACRYLIQUE
ACRÍLICO

TAPS ROBINETS GRIFERÍA

-  **CLICK WASTE VALVE**
VIDAGE CLICK
DESAGÜE CLICK
-  **AUTOMATIC WASTE VALVE**
VIDAGE AUTOMATIQUE
DESAGÜE AUTOMÁTICO
-  **SUPPLIED IN A BOX**
FOURNI DANS UNE BOÎTE
SUMINISTRADO EN UNA CAJA
-  **THERMOSTATIC TAP**
ROBINETS THERMOSTATIQUES
GRIFERÍA TERMOSTÁTICA
-  **ELECTRONIC TAPS**
ROBINETS ÉLECTRONIQUES
GRIFERÍA ELECTRÓNICA
-  **ELECTRICAL OUTLET**
BRANCHEMENT
ENCHUFE ELÉCTRICO
-  **BATTERIES' DESCRIPTION**
DESCRIPTION DES BATTERIES
DESCRIPCIÓN DE LAS PILAS
-  **SENSOR**
CAPTEUR
SENSOR
-  **SELF-CLOSING TAPS**
ROBINETS TEMPORISÉS
GRIFERÍA TEMPORIZADA
-  **RAIN**
RAIN
RAIN
-  **RAIN ECO**
RAIN ECO
RAIN ECO
-  **MASSAGE**
MASSAGE
MASAJE
-  **RAIN & MASSAGE**
RAIN & MASSAGE
RAIN Y MASAJE
-  **MIXED**
MIXTE
MEZCLADO
-  **RAIN & MIXED**
RAIN & MIXTE
RAIN Y MEZCLADO
-  **STOP**
STOP
STOP
-  **EASY CLEANING**
NETTOYAGE FACILE
LIMPIEZA FÁCIL
-  **BUBBLING**
BUBBLING
BUBBLING
-  **RAIN & BUBBLING**
RAIN & BUBBLING
RAIN Y BUBBLING

KITCHEN SINKS ÉVIERS DE CUISINE FREGADEROS

-  **INSET**
À ENCASTRER
ENCASTRABLE
-  **UNDERMOUNT**
SOUS PLAN
BAJO ENCIMERA
-  **REVERSIBLE**
RÉVERSIBLE
REVERSIBLE
-  **SIMPLE SIPHON**
SIPHON SIMPLE
SIFÓN SIMPLE
-  **DOUBLE SIPHON**
SIPHON DOUBLE
SIFÓN DOBLE
-  **UNIT BOX**
BOÎTE À L'UNITÉ
CAJA UNITARIA
-  **CARTON SLEEVE**
CADRE DE CARTE
MARCO DE CARTÓN
-  **SUPPLIED IN A PLASTIC BAG**
FOURNI DANS UN SAC EN PLASTIQUE
SUMINISTRADO EN BOLSA DE PLÁSTICO
-  **MULTIPLE BOX**
BOÎTE MULTIPLE
CAJA MÚLTIPLE

FINISHES | FINITIONS | ACABADOS

In each model you will see an identification of the finishes available in stock and the finishes available upon request. To make it easier for you to identify it, you will have the following visual indication:

Dans chaque modèle, vous verrez l'identification des finitions disponibles en stock et des finitions disponibles sur demande. Pour simplifier cette identification, vous aurez l'indication visuelle suivante:

En cada modelo de mueble verás la identificación de los acabados disponibles en stock y de los acabados disponibles bajo pedido. Para simplificar esta identificación, tendrás la siguiente indicación visual:



REGULAR PRODUCTION AVAILABLE FINISHES
FINITIONS DISPONIBLES DE PRODUCTION RÉGULIÈRE
ACABADOS DISPONIBLES DE PRODUCCIÓN REGULAR



FINISHES AVAILABLE UPON REQUEST
FINITIONS DISPONIBLES SUR DEMANDE
ACABADOS DISPONIBLES BAJO PEDIDO

COLORS | COULEURS | COLORES

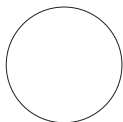

WHITE
BLANC
BLANCO



ESTEPA
ESTEPA
ESTEPA



TAIGA
TAIGA
TAIGA

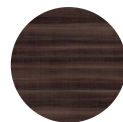

TEA
TEA
TEA



HERA
HERA
HERA



CTESI COLORS
COULEURS CTESI
COLORES CTESI



RAL® COLORS
COULEURS RAL®
COLORES RAL®

CTESI COLORS (available in glossy and matte finishes)
COULEURS CTESI (disponibles en finitions brillante et mate)
COLORES CTESI (disponibles en acabado brillante y mate)

 WHITE
BLANC
BLANCO

 MIDNIGHT BLUE
BLEU MINUIT
AZUL MEDIANOCHÉ

 BLUE
BLEU
AZUL

 CEMENT GREEN
VERT CIMENT
VERDE CEMENTO

 GRAY
GRIS
GRIS

 SALMON
SALMON
SALMÓN

 ANTRACITE
ANTHRACITE
ANTRACITE

 BLACK
NOIR
NEGRO

- 06** **bathroom furniture**
meubles de salle de bain
muebles de baño
- 26** **mirrored cabinets**
armoires avec miroirs
armarios con espejos
- 27** **mirrors**
miroirs
espejos
- 32** **ceramic countertops**
vasques en céramique
lavabos de cerámica
- 38** **taps**
robinets
grifos
- 48** **shower columns**
colonnes de douche
columnas de ducha
- 52** **handshowers**
douches à main
duchas de mano
- 54** **sliding rails and holders**
barres de douche et supports
barras y soportes
- 55** **flexible hoses**
flexibles de douche
flexibles
- 56** **hygienic showers kit**
set douchettes hygiéniques
kit duchas higiénicas
- 60** **towel holders**
porte-serviettes
toalleros
- 68** **handicapped** *clean & safe*
handicapped *clean & safe*
handicapped *clean & safe*
- 69** **sanitary ware** *clean & safe*
appareils sanitaires *clean & safe*
cerámica sanitaria *clean & safe*
- 69** **baby changing stations** *clean & safe*
tables à langer *clean & safe*
cambiadores de bebé *clean & safe*
- 70** **grab bar** *clean & safe*
barres d'appui *clean & safe*
asideros *clean & safe*
- 71** **shower seats** *clean & safe*
sièges de douche *clean & safe*
asientos de ducha *clean & safe*
- 72** **hand dryers and toilet bins** *clean & safe*
sèche-mains et corbeilles à papiers *clean & safe*
secadoras de manos y papeleras *clean & safe*
- 73** **paper dispensers** *clean & safe*
distributeurs de papier *clean & safe*
dispensadores de papel *clean & safe*
- 74** **soap dispensers** *clean & safe*
distributeurs de savon *clean & safe*
dispensadores de jabón *clean & safe*
- 76** **single lever mixer tap** *clean & safe*
robinet mitigeur *clean & safe*
grifos monomando *clean & safe*
- 78** **electronic taps** *clean & safe*
robinets électroniques *clean & safe*
grifería electrónica *clean & safe*
- 80** **self-closing taps** *clean & safe*
robinets temporisés *clean & safe*
grifería temporizada *clean & safe*
- 82** **foot operated taps** *clean & safe*
mitigeurs commande au pied *clean & safe*
grifos de pedal *clean & safe*
- 83** **spouts** *clean & safe*
becs *clean & safe*
caños *clean & safe*
- 86** **shower enclosures and panels**
parois et panneaux de douche
mamparas y paneles de ducha
- 112** **shower trays**
receveurs de douche
platos de ducha
- 118** **electric towel heaters**
sèche-serviettes électriques
toalleros eléctricos
- 121** **kitchen sinks**
évier de cuisine
fregaderos



bathroom furniture *meubles de salle de bain* **muebles de baño**

Furniture is a crucial item for any bathroom. It defines its style, environment and its amount of available storage space. Find out our entire range of high quality suspended or footed furniture that can be matched with countertop or built-in washbasins.

Les meubles sont un élément crucial pour toute salle de bain. Ils définissent le style, l'environnement e la quantité d'espace de stockage disponible. Découvrez toute notre gamme de meubles suspendus ou avec pieds, de haute qualité, qui peuvent être combinés avec des vasques à poser ou à encastrer.

Los muebles son elementos esenciales de cualquier espacio de baño y determinan su estilo, ambiente deseado, almacenamiento y organización. Descubre toda la gama de muebles suspendidos o con patas, de calidad superior y que se pueden combinar con diferentes lavabos empotrables o de encimera.



100 cm SUSPENDED BASE UNIT - ESTEPA · COTTON COUNTERTOP WASHBASIN · 100x50 cm SIMPLE MIRROR
 MUEBLE SUSPENDU 100 cm - ESTEPA · VASQUE À POSER COTTON · MIROIR SIMPLE 100x50 cm
 MUEBLE SUSPENDIDO 100 cm - ESTEPA · LAVABO DE ENCIMERA COTTON · ESPEJO SIMPLE 100x50 cm



WHITE
BLANC
BLANCO



ESTEPA
ESTEPA
ESTEPA



TAIGA
TAIGA
TAIGA



TEA
TEA
TEA



HERA
HERA
HERA



CTESI COLORS
COULEURS CTESI
COLORES CTESI



RAL® COLORS
COULEURS RAL®
COLORES RAL®

SUSPENDED BASE UNIT
MUEBLE SUSPENDU
MUEBLE SUSPENDIDO



60 1 DRAWER
1 TIROIR
1 CAJON
60 45 17

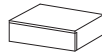

80 1 DRAWER
1 TIROIR
1 CAJON
80 45 17



100 1 DRAWER
1 TIROIR
1 CAJON
100 45 17



120 1 DRAWER
1 TIROIR
1 CAJON
120 45 17

- WHITE | BLANC | BLANCO
- ESTEPA | ESTEPA | ESTEPA
- TAIGA | TAIGA | TAIGA
- TEA | TEA | TEA
- HERA | HERA | HERA

CTESI COLORS®
COULEURS CTESI®
COLORES CTESI®

RAL® COLORS
COULEURS RAL®
COLORES RAL®

| | 60 | 80 | 100 | 120 |
|--|-----------|-----------|-----------|-----------|
| | REF. | REF. | REF. | REF. |
| WHITE BLANC BLANCO | BL0542000 | BL0542100 | BL0542200 | BL0542300 |
| ESTEPA ESTEPA ESTEPA | BL0542080 | BL0542180 | BL0542280 | BL0542380 |
| TAIGA TAIGA TAIGA | BL0542081 | BL0542181 | BL0542281 | BL0542381 |
| TEA TEA TEA | BL0542085 | BL0542185 | BL0542285 | BL0542385 |
| HERA HERA HERA | BL0542086 | BL0542186 | BL0542286 | BL0542386 |
| CTESI COLORS® COULEURS CTESI® COLORES CTESI® | - | - | - | - |
| RAL® COLORS COULEURS RAL® COLORES RAL® | - | - | - | - |



60 cm SUSPENDED BASE UNIT - WHITE · COTTON COUNTERTOP WASHBASIN
60x50 cm LESS MIRROR · 30 cm CLEAR LED LIGHT FIXTURE
MUEBLE SUSPENDU 60 cm - BLANC · VASQUE À POSER COTTON
MIROIR LESS 60x50 cm · APPLIQUE LED CLEAR 30 cm
MUEBLE SUSPENDIDO 60 cm - BLANCO · LAVABO DE ENCIMERA COTTON
ESPEJO LESS 60x50 cm · APLIQUE CLEAR 30 cm

CLEAR LED LIGHT FIXTURE
APPLIQUE LED CLEAR | APLIQUE CLEAR

| REF. | LEDS | MEASURES / MESURES / MEDIDAS |
|-----------|------|------------------------------|
| BL5520000 | 6W | 30 cm |
| BL5520010 | 6W | 50 cm |

LESS MIRROR | MIROIR LESS | ESPEJO LESS

| REF. | MEASURES / MESURES / MEDIDAS |
|-----------|------------------------------|
| BL1004510 | 60 x 50 cm |
| BL1004520 | 80 x 50 cm |
| BL1004540 | 100 x 50 cm |
| BL1004560 | 120 x 50 cm |

SIMPLE MIRROR
MIROIR SIMPLE | ESPEJO SIMPLE

| REF. | MEASURES / MESURES / MEDIDAS |
|-----------|------------------------------|
| BL8900220 | 60 x 50 cm |
| BL8900230 | 80 x 50 cm |
| BL8900240 | 100 x 50 cm |
| BL8900250 | 120 x 50 cm |

CHECK OUR MIRROR RANGE ON **PAGE 24**
CONSULTEZ NOTRE GAMME DE MIROIRS SUR LA **PAGE 24**
VEE NUESTRA GAMA DE ESPEJOS EN LA **PÁGINA 24**



100 cm SUSPENDED BASE UNIT WITH 4 DRAWERS - TEA
 101 cm LEFT CERAMIC WASHBASIN · 100x60 cm SUNNY LEDS MIRROR
 MEUBLE SUSPENDU 100 cm AVEC 4 TIROIRS - TEA
 LAVABO LEFT EN CÉRAMIQUE 101 cm · MIROIR LEDS SUNNY 100x60 cm
 MUEBLE SUSPENDIDO 100 cm CON 4 CAJONES - TEA
 LAVABO LEFT DE CERÁMICA 101 cm · ESPEJO LEDS SUNNY 100x60 cm



80 cm SUSPENDED BASE UNIT WITH 4 DRAWERS - TAIGA
 81 cm LEFT CERAMIC WASHBASIN · 80x50 cm SIMPLE MIRROR
 MEUBLE SUSPENDU 80 cm AVEC 4 TIROIRS - TAIGA
 LAVABO LEFT EN CÉRAMIQUE 81 cm · MIROIR SIMPLE 80x50 cm
 MUEBLE SUSPENDIDO 80 cm CON 4 CAJONES - TAIGA
 LAVABO LEFT DE CERÁMICA 81 cm · ESPEJO SIMPLE 80x50 cm



WHITE
BLANC
BLANCO



ESTEPA
ESTEPA
ESTEPA



TAIGA
TAIGA
TAIGA



TEA
TEA
TEA



HERA
HERA
HERA

CHECK THE TOP COVERS' FEATURES ON PAGE 23
 VÉRIFIEZ LES CARACTÉRISTIQUES DES PLATEAUX SUPÉRIEURS SUR LA PAGE 23
 VEE LAS ESPECIFICACIONES DE LAS TAPAS EN LA PÁGINA 23

SUSPENDED BASE UNIT
MUEBLE SUSPENDU
MUEBLE SUSPENDIDO

BASE UNIT WITH LEFT CERAMIC WASHBASIN
MEUBLE AVEC LAVABO LEFT EN CÉRAMIQUE
MUEBLE CON LAVABO LEFT DE CERÁMICA



80 4 DRAWERS
4 TIROIRS
4 CAJONES
80 45 60

REF.



100 4 DRAWERS
4 TIROIRS
4 CAJONES
100 45 60

REF.



120 4 DRAWERS
4 TIROIRS
4 CAJONES
120 45 60

REF.



80 4 DRAWERS
4 TIROIRS
4 CAJONES
80 45 60

REF.



100 4 DRAWERS
4 TIROIRS
4 CAJONES
100 45 60

REF.



120 4 DRAWERS
4 TIROIRS
4 CAJONES
120 45 60

REF.

WHITE | BLANC | BLANCO*

ESTEPA | ESTEPA | ESTEPA

TAIGA | TAIGA | TAIGA

TEA | TEA | TEA

HERA | HERA | HERA

BL8131000

BL8132000

BL8133000

BL8131500

BL8132500

BL8133500

BL8131080

BL8132080

BL8133080

BL8131580

BL8132580

BL8133580

BL8131081

BL8132081

BL8133081

BL8131581

BL8132581

BL8133581

BL8131085

BL8132085

BL8133085

BL8131585

BL8132585

BL8133585

BL8131086

BL8132086

BL8133086

BL8131586

BL8132586

BL8133586

*Lacquered fronts | Façades laquées | Frentes lacadas



BASE UNIT FEET
PIEDS POUR MEUBLES
PATAS PARA MUEBLE

3.5 3.5 20

REF.

4 FEET
4 PIEDS
4 PATAS

BL0550100

1 FOOT
1 PIED
1 PATA

BL0550105



soft-close
soft-close
cierre suave

120 cm SUSPENDED BASE UNIT WITH 4 DRAWERS - HERA
121 cm LEFT CERAMIC WASHBASIN
120x50 cm SIMPLE MIRROR · 50 cm CLEAR LED LIGHT FIXTURE
140 cm PURE SUSPENDED COLUMN WITH 2 DOORS - HERA

MEUBLE SUSPENDU 120 cm AVEC 4 TIROIRS - HERA

LAVABO LEFT EN CÉRAMIQUE 121 cm

MIROIR SIMPLE 120x50 cm · APPLIQUE LED CLEAR 50 cm

COLONNE SUSPENDUE PURE 140 cm AVEC 2 PORTES - HERA

MUEBLE SUSPENDIDO 120 cm CON 4 CAJONES - HERA

LAVABO LEFT DE CERÁMICA 121 cm

ESPEJO SIMPLE 120x50 cm · APLIQUE CLEAR 50 cm

COLUMNA SUSPENDIDA PURE 140 cm CON 2 PUERTAS - HERA

CLEAR LED LIGHT FIXTURE
APPLIQUE LED CLEAR | APLIQUE CLEAR

| REF. | LEDS | MEASURES / MESURES / MEDIDAS |
|-----------|------|------------------------------|
| BL5520000 | 6W | 30 cm |
| BL5520010 | 6W | 50 cm |

SUNNY LEDS MIRROR | MIROIR SUNNY
AVEC LEDS | ESPEJO SUNNY CON LEDS

| REF. | LEDS | MEASURES / MESURES / MEDIDAS |
|-----------|--------|------------------------------|
| BL5007415 | 1x 8W | 60 x 60 cm |
| BL5007425 | 1x 14W | 80 x 60 cm |
| BL5007435 | 1x 18W | 100 x 60 cm |
| BL5007445 | 1x 18W | 120 x 60 cm |

SIMPLE MIRROR
MIROIR SIMPLE | ESPEJO SIMPLE

| REF. | MEASURES / MESURES / MEDIDAS |
|-----------|------------------------------|
| BL8900220 | 60 x 50 cm |
| BL8900230 | 80 x 50 cm |
| BL8900240 | 100 x 50 cm |
| BL8900250 | 120 X 50 cm |



80 cm SUSPENDED BASE UNIT WITH 2 DRAWERS / 1 DOOR - WHITE
81 cm LEFT CERAMIC WASHBASIN · 80x50 cm LESS MIRROR
MEUBLE SUSPENDU 80 cm AVEC 2 TIROIRS / 1 PORTE - BLANC
LAVABO LEFT EN CÉRAMIQUE 81 cm · MIROIR LESS 80x50 cm
MUEBLE SUSPENDIDO 80 cm CON 2 CAJONES / 1 PUERTA - BLANCO
LAVABO LEFT DE CERÁMICA 81 cm · ESPEJO LESS 80x50 cm



100 cm SUSPENDED BASE UNIT WITH 2 DRAWERS / 1 DOOR - ESTEPA
101 cm LEFT CERAMIC WASHBASIN · 100x60 cm SUNNY LEDS MIRROR
MEUBLE SUSPENDU 100 cm AVEC 2 TIROIRS / 1 PORTE - ESTEPA
LAVABO LEFT EN CÉRAMIQUE 101 cm · MIROIR SUNNY AVEC LEDS 100x60 cm
MUEBLE SUSPENDIDO 100 cm CON 2 CAJONES / 1 PUERTA - ESTEPA
LAVABO LEFT DE CERÁMICA 101 cm · ESPEJO SUNNY CON LEDS 100x60 cm



WHITE
BLANC
BLANCO



ESTEPA
ESTEPA
ESTEPA



TAIGA
TAIGA
TAIGA



TEA
TEA
TEA



HERA
HERA
HERA

CHECK THE TOP COVERS' FEATURES ON PAGE 23
VÉRIFIEZ LES CARACTÉRISTIQUES DES PLATEAUX SUPÉRIEURS SUR LA PAGE 23
VEE LAS ESPECIFICACIONES DE LAS TAPAS EN LA PÁGINA 23

BASE UNIT WITH LEFT CERAMIC WASHBASIN
MEUBLE AVEC LAVABO LEFT EN CÉRAMIQUE
MUEBLE CON LAVABO LEFT DE CERÁMICA

BASE UNIT WITH TOP COVER
MEUBLE AVEC PLATEAU SUPÉRIEUR
MUEBLE CON TAPA

SUSPENDED BASE UNIT
MUEBLE SUSPENDU
MUEBLE SUSPENDIDO



80 2 DRAWERS / 1 DOOR
2 TIROIRS / 1 PORTE
2 CAJONES / 1 PUERTA

80 45 60

REF.



100 2 DRAWERS / 1 DOOR
2 TIROIRS / 1 PORTE
2 CAJONES / 1 PUERTA

100 45 60

REF.



120 2 DRAWERS / 1 DOOR
2 TIROIRS / 1 PORTE
2 CAJONES / 1 PUERTA

120 45 60

REF.



80 2 DRAWERS / 1 DOOR
2 TIROIRS / 1 PORTE
2 CAJONES / 1 PUERTA

80 45 60

REF.

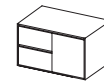

100 2 DRAWERS / 1 DOOR
2 TIROIRS / 1 PORTE
2 CAJONES / 1 PUERTA

100 45 60

REF.



120 2 DRAWERS / 1 DOOR
2 TIROIRS / 1 PORTE
2 CAJONES / 1 PUERTA

120 45 60

REF.

WHITE | BLANC | BLANCO*

ESTEPA | ESTEPA | ESTEPA

TAIGA | TAIGA | TAIGA

TEA | TEA | TEA

HERA | HERA | HERA

BL8121000

BL8122000

BL8123000

BL8121500

BL8122500

BL8123500

BL8121080

BL8122080

BL8123080

BL8121580

BL8122580

BL8123580

BL8121081

BL8122081

BL8123081

BL8121581

BL8122581

BL8123581

BL8121085

BL8122085

BL8123085

BL8121585

BL8122585

BL8123585

BL8121086

BL8122086

BL8123086

BL8121586

BL8122586

BL8123586

*Lacquered fronts | Façades laquées | Frentes lacadas



BASE UNIT FEET
PIEDS POUR MEUBLES
PATAS PARA MUEBLE



| REF. |
|------------------------------|
| 4 FEET 4 PIEDS 4 PATAS |
| 1 FOOT 1 PIED 1 PATA |

BL0550100

BL0550105



soft-close
soft-close
cierre suave

120 cm SUSPENDED BASE UNIT WITH 2 DRAWERS / 1 DOOR - HERA
121 cm LEFT CERAMIC WASHBASIN
120x50 cm LESS MIRROR - 50 cm CLEAR LED LIGHT FIXTURE
140 cm PURE SUSPENDED COLUMN WITH 2 DOORS - HERA
MEUBLE SUSPENDU 120 cm AVEC 2 TIROIRS / 1 PORTE - HERA
LAVABO LEFT EN CÉRAMIQUE 121 cm
MIROIR LESS 120x50 cm · APPLIQUE LED CLEAR 50 cm
COLONNE SUSPENDUE PURE 140 cm AVEC 2 PORTES - HERA
MUEBLE SUSPENDIDO 120 cm CON 2 CAJONES / 1 PUERTA - HERA
LAVABO LEFT DE CÉRAMICA 121 cm
ESPEJO LESS 120x50 cm · APLIQUE CLEAR 50 cm
COLUMNA SUSPENDIDA PURE 140 cm CON 2 PUERTAS - HERA

CLEAR LED LIGHT FIXTURE
APPLIQUE LED CLEAR | APLIQUE CLEAR

| REF. | LEDS | MEASURES / MESURES / MEDIDAS |
|-----------|------|------------------------------|
| BL5520000 | 6W | 30 cm |
| BL5520010 | 6W | 50 cm |

LESS MIRROR | MIROIR LESS | ESPEJO LESS

| REF. | MEASURES / MESURES / MEDIDAS |
|-----------|------------------------------|
| BL1004510 | 60 x 50 cm |
| BL1004520 | 80 x 50 cm |
| BL1004540 | 100 x 50 cm |
| BL1004560 | 120 x 50 cm |

SUNNY LEDS MIRROR | MIROIR SUNNY
AVEC LEDS | ESPEJO SUNNY CON LEDS

| REF. | LEDS | MEASURES / MESURES / MEDIDAS |
|-----------|--------|------------------------------|
| BL5007415 | 1x 8W | 60 x 60 cm |
| BL5007425 | 1x 14W | 80 x 60 cm |
| BL5007435 | 1x 18W | 100 x 60 cm |
| BL5007445 | 1x 18W | 120 x 60 cm |



60 cm SUSPENDED BASE UNIT WITH 2 DRAWERS - HERA (2 UNITS) • 61 cm RECTO WASHBASIN (2 UNITS) • 60x50 cm LESS MIRROR (2 UNITS) • 30 cm CLEAR LED LIGHT FIXTURE (2 UNITS) • 140 cm PURE SUSPENDED COLUMN WITH 2 DOORS - HERA
 MEUBLE SUSPENDU 60 cm AVEC 2 TIROIRS - HERA (2 UNITÉS) • LAVABO RECTO 61 cm (2 UNITÉS) • MIROIR LESS 60x50 cm (2 UNITÉS) • APPLIQUE LED CLEAR 30 cm (2 UNITÉS) • COLONNE SUSPENDUE PURE 140 cm AVEC 2 PORTES - HERA
 MUEBLE SUSPENDIDO 60 cm CON 2 CAJONES - HERA (2 UNIDADES) • LAVABO RECTO 61 cm (2 UNIDADES) • ESPEJO LESS 60x50 cm (2 UNIDADES) • APLIQUE CLEAR 30 cm (2 UNIDADES) • COLUMNA SUSPENDIDA PURE 140 cm CON 2 PUERTAS - HERA



WHITE
BLANC
BLANCO

ESTEPA
ESTEPA
ESTEPA

TAIGA
TAIGA
TAIGA

TEA
TEA
TEA

HERA
HERA
HERA

CHECK THE TOP COVERS' FEATURES ON PAGE 23
VÉRIFIEZ LES CARACTÉRISTIQUES DES PLATEAUX SUPÉRIEURS SUR LA PAGE 23
VEE LAS ESPECIFICACIONES DE LAS TAPAS EN LA PÁGINA 23

BASE UNIT WITH RECTO CERAMIC WASHBASIN
MEUBLE AVEC LAVABO RECTO EN CÉRAMIQUE
MUEBLE CON LAVABO RECTO DE CERÁMICA

BASE UNIT WITH TOP COVER
MEUBLE AVEC PLATEAU SUPÉRIEUR
MUEBLE CON TAPA

SUSPENDED
BASE UNIT
MEUBLE
SUSPENDU
MUEBLE
SUSPENDIDO

| 60 | 80 | 100 | 120 | 60 | 80 | 100 | 120 |
|-------------------------------------|-------------------------------------|-------------------------------------|-------------------------------------|-------------------------------------|-------------------------------------|-------------------------------------|-------------------------------------|
| 2 DRAWERS 2 TIROIRS 2 CAJONES | 2 DRAWERS 2 TIROIRS 2 CAJONES | 2 DRAWERS 2 TIROIRS 2 CAJONES | 4 DRAWERS 4 TIROIRS 4 CAJONES | 2 DRAWERS 2 TIROIRS 2 CAJONES | 2 DRAWERS 2 TIROIRS 2 CAJONES | 2 DRAWERS 2 TIROIRS 2 CAJONES | 4 DRAWERS 4 TIROIRS 4 CAJONES |
| 60 45 60 | 80 45 60 | 100 45 60 | 120 45 60 | 60 45 60 | 80 45 60 | 100 45 60 | 120 45 60 |
| REF. | REF. | REF. | REF. | REF. | REF. | REF. | REF. |
| BL8100000 | BL8101000 | BL8102000 | BL8103000 | BL8100500 | BL8101500 | BL8102500 | BL8103500 |
| BL8100080 | BL8101080 | BL8102080 | BL8103080 | BL8100580 | BL8101580 | BL8102580 | BL8103580 |
| BL8100081 | BL8101081 | BL8102081 | BL8103081 | BL8100581 | BL8101581 | BL8102581 | BL8103581 |
| BL8100085 | BL8101085 | BL8102085 | BL8103085 | BL8100585 | BL8101585 | BL8102585 | BL8103585 |
| BL8100086 | BL8101086 | BL8102086 | BL8103086 | BL8100586 | BL8101586 | BL8102586 | BL8103586 |

*Lacquered fronts | Façades laquées | Frontes lacadas



BASE UNIT FEET
PIEDS POUR MEUBLES
PATAS PARA MUEBLE

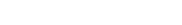
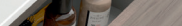
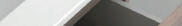
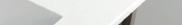
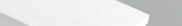
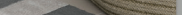
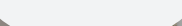
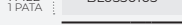
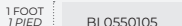
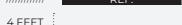
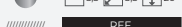
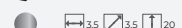

80cm SUSPENDED BASE UNIT WITH 2 DRAWERS - ESTEPA
81 cm RECTO WASHBASIN • 80x60 cm SUNNY LEDS MIRROR
140 cm PURE SUSPENDED COLUMN WITH 2 DOORS - ESTEPA
MEUBLE SUSPENDU 80 cm AVEC 2 TIROIRS - ESTEPA
LAVABO RECTO 81 cm • MIROIR SUNNY AVEC LEDS 80x60 cm
COLONNE SUSPENDUE PURE 140 cm AVEC 2 PORTES - ESTEPA
MUEBLE SUSPENDIDO 80 cm CON 2 CAJONES - ESTEPA
LAVABO RECTO 81 cm • ESPEJO SUNNY CON LEDS 80x60 cm
COLUMNA SUSPENDIDA PURE 140 cm CON 2 PUERTAS - ESTEPA

CLEAR LED LIGHT FIXTURE
APPLIQUE LED CLEAR | APLIQUE CLEAR

| REF. | LEDS | MEASURES MESURES MEDIDAS |
|-----------|------|------------------------------|
| BL5520000 | 6W | 30 cm |
| BL5520010 | 6W | 50 cm |

LESS MIRROR | MIROIR LESS | ESPEJO LESS

| REF. | MEASURES MESURES MEDIDAS |
|-----------|------------------------------|
| BL1004510 | 60 x 50 cm |
| BL1004520 | 80 x 50 cm |
| BL1004540 | 100 x 50 cm |
| BL1004560 | 120 x 50 cm |

SUNNY LEDS MIRROR | MIROIR SUNNY
AVEC LEDS | ESPEJO SUNNY CON LEDS

| REF. | LEDS | MEASURES MESURES MEDIDAS |
|-----------|--------|------------------------------|
| BL5007415 | 1x 8W | 60 x 60 cm |
| BL5007425 | 1x 14W | 80 x 60 cm |
| BL5007435 | 1x 18W | 100 x 60 cm |
| BL5007445 | 1x 18W | 120 x 60 cm |



soft-close
soft-close
cierre suave



80 cm BASE UNIT WITH 3 DRAWERS - WHITE
81 cm RECTO WASHBASIN · 80x50 cm LESS MIRROR
MEUBLE 80 cm AVEC 3 TIROIRS - BLANC
LAVABO RECTO 81 cm · MIROIR LESS 80x50 cm
MUEBLE 80 cm CON 3 CAJONES - BLANCO
LAVABO RECTO 81 cm · ESPEJO LESS 80x50 cm



60 cm BASE UNIT WITH 3 DRAWERS - TAIGA · 61 cm RECTO WASHBASIN
60x50 cm LESS MIRROR · 30 cm CLEAR LED LIGHT FIXTURE
MEUBLE 60 cm AVEC 3 TIROIRS - TAIGA · LAVABO RECTO 61 cm
MIROIR LESS 60x50 cm · APPLIQUE LED CLEAR 30 cm
MUEBLE 60 cm CON 3 CAJONES - TAIGA · LAVABO RECTO 61 cm
ESPEJO LESS 60x50 cm · APLIQUE CLEAR 30 cm



WHITE
BLANC
BLANCO



ESTEPA
ESTEPA
ESTEPA



TAIGA
TAIGA
TAIGA



TEA
TEA
TEA



HERA
HERA
HERA

BASE UNIT WITH RECTO CERAMIC WASHBASIN
MEUBLE AVEC LAVABO RECTO EN CÉRAMIQUE
MUEBLE CON LAVABO RECTO DE CERÁMICA

BASE UNIT WITH FEET
MUEBLE AVEC PIEDS
MUEBLE CON PATAS



60 3 DRAWERS
3 TIROIRS
3 CAJONES
60 45 80

REF.



80 3 DRAWERS
3 TIROIRS
3 CAJONES
80 45 80

REF.



100 3 DRAWERS
3 TIROIRS
3 CAJONES
100 45 80

REF.

- WHITE | BLANC | BLANCO*
- ESTEPA | ESTEPA | ESTEPA
- TAIGA | TAIGA | TAIGA
- TEA | TEA | TEA
- HERA | HERA | HERA

| |
|-----------|
| BL8110000 |
| BL8110080 |
| BL8110081 |
| BL8110085 |
| BL8110086 |

| |
|-----------|
| BL8111000 |
| BL8111080 |
| BL8111081 |
| BL8111085 |
| BL8111086 |

| |
|-----------|
| BL8112000 |
| BL8112080 |
| BL8112081 |
| BL8112085 |
| BL8112086 |

*Lacquered fronts | Façades laquées | Frontes lacadas

SUNNY LEDS MIRROR | MIROIR SUNNY
AVEC LEDS | ESPEJO SUNNY CON LEDS

| REF. | LEDS | MEASURES / MESURES / MEDIDAS |
|-----------|--------|------------------------------|
| BL5007415 | 1x 8W | 60 x 60 cm |
| BL5007425 | 1x 14W | 80 x 60 cm |
| BL5007435 | 1x 18W | 100 x 60 cm |
| BL5007445 | 1x 18W | 120 x 60 cm |

CLEAR LED LIGHT FIXTURE
APPLIQUE LED CLEAR | APLIQUE CLEAR

| REF. | LEDS | MEASURES / MESURES / MEDIDAS |
|-----------|------|------------------------------|
| BL5520000 | 6W | 30 cm |
| BL5520010 | 6W | 50 cm |

LESS MIRROR | MIROIR LESS | ESPEJO LESS

| REF. | MEASURES / MESURES / MEDIDAS |
|-----------|------------------------------|
| BL1004510 | 60 x 50 cm |
| BL1004520 | 80 x 50 cm |
| BL1004540 | 100 x 50 cm |
| BL1004560 | 120 x 50 cm |



soft-close
 soft-close
 cierre suave

80cm BASE UNIT WITH 3 DRAWERS - HERA
 81 cm RECTO WASHBASIN · 80x60 cm SUNNY LEDS MIRROR
 140 cm PURE SUSPENDEO COLUMN WITH 2 DOORS - HERA
 MEUBLE 80 cm AVEC 3 TIROIRS - HERA
 LAVABO RECTO 81 cm · MIROIR SUNNY AVEC LEDS 80x60 cm
 COLONNE SUSPENDUE PURE 140 cm AVEC 2 PORTES - HERA
 MUEBLE 80 cm CON 3 CAJONES - HERA
 LAVABO RECTO 81 cm · ESPEJO SUNNY CON LEDS 80x60 cm
 COLUMNA SUSPENDIDA PURE 140 cm CON 2 PUERTAS - HERA

80cm BASE UNIT WITH 3 DRAWERS - TEA
 81 cm RECTO WASHBASIN
 140 cm PURE SUSPENDEO COLUMN WITH 2 DOORS - TEA
 MEUBLE 80 cm AVEC 3 TIROIRS - TEA
 LAVABO RECTO 81 cm
 COLONNE SUSPENDUE PURE 140 cm AVEC 2 PORTES - TEA
 MUEBLE 80 cm CON 3 CAJONES - TEA
 LAVABO RECTO 81 cm
 COLUMNA SUSPENDIDA PURE 140 cm CON 2 PUERTAS - TEA



80 cm BASE UNIT WITH 2 DRAWERS / 2 DOORS - TAIGA · BASE UNIT FEET (4 UNITS) · 81 cm RECTO WASHBASIN · 80x50 cm LESS MIRROR
MEUBLE 80 cm AVEC 2 TIROIRS / 2 PORTES - TAIGA · PIEDS POUR MEUBLES (4 UNITÉS) · LAVABO RECTO 81 cm · MIROIR LESS 80x50 cm
MUEBLE 80 cm CON 2 CAJONES / 2 PUERTAS - TAIGA · PATAS PARA MUEBLE (4 UNIDADES) · LAVABO RECTO 81 cm · ESPEJO LESS 80x50 cm



WHITE
BLANC
BLANCO



ESTEPA
ESTEPA
ESTEPA



TAIGA
TAIGA
TAIGA



TEA
TEA
TEA



HERA
HERA
HERA

BASE UNIT WITH **RECTO** CERAMIC WASHBASIN
MEUBLE AVEC LAVABO **RECTO** EN CÉRAMIQUE
MUEBLE CON LAVABO RECTO DE CERÁMICA

BASE UNIT WITH **MODERN** CERAMIC WASHBASIN
MEUBLE AVEC LAVABO **MODERN** EN CÉRAMIQUE
MUEBLE CON LAVABO MODERN DE CERÁMICA

SUSPENDED BASE UNIT
MUEBLE SUSPENDU
MUEBLE SUSPENDIDO



60 2 DRAWERS / 1 DOOR
2 TIROIRS / 1 PORTE
2 CAJONES / 1 PUERTA
60 45 60

REF.



80 2 DRAWERS / 2 DOORS
2 TIROIRS / 2 PORTES
2 CAJONES / 2 PUERTAS
80 45 60

REF.



100 2 DRAWERS / 2 DOORS
2 TIROIRS / 2 PORTES
2 CAJONES / 2 PUERTAS
100 45 60

REF.



120 4 DRAWERS / 2 DOORS
4 TIROIRS / 2 PORTES
4 CAJONES / 2 PUERTAS
120 45 60

REF.



120 2 DRAWERS / 2 DOORS
2 TIROIRS / 2 PORTES
2 CAJONES / 2 PUERTAS
120 45 60

REF.

SINGLE BOWL
CUVE SEULE
1 CUBETA

TWO BOWLS
2 CUVES
2 CUBETAS

WHITE | BLANC | BLANCO*

ESTEPA | ESTEPA | ESTEPA

TAIGA | TAIGA | TAIGA

TEA | TEA | TEA

HERA | HERA | HERA

BL8140100

BL8140200

BL8140300

BL8140400

BL8140500

BL8140180

BL8140280

BL8140380

BL8140480

BL8140580

BL8140181

BL8140281

BL8140381

BL8140481

BL8140581

BL8140185

BL8140285

BL8140385

BL8140485

BL8140585

BL8140186

BL8140286

BL8140386

BL8140486

BL8140586

*Lacquered fronts | Façades laquées | Frentes lacadas



BASE UNIT FEET
PIEDS POUR MEUBLES
PATAS PARA MUEBLE

3.5 3.5 20

REF.

4 FEET
4 PIEDS
4 PATAS

BL0550100

1 FOOT
1 PIED
1 PATA

BL0550105



CLEAR LED LIGHT FIXTURE
APPLIQUE LED CLEAR | APLIQUE CLEAR

| REF. | LEDS | MEASURES / MESURES / MEDIDAS |
|-----------|------|------------------------------|
| BL5520000 | 6W | 30 cm |
| BL5520010 | 6W | 50 cm |

LESS MIRROR | MIROIR LESS | ESPEJO LESS

| REF. | MEASURES / MESURES / MEDIDAS |
|-----------|------------------------------|
| BL1004510 | 60 x 50 cm |
| BL1004520 | 80 x 50 cm |
| BL1004540 | 100 x 50 cm |
| BL1004560 | 120 x 50 cm |

SIMPLE MIRROR
MIROIR SIMPLE | ESPEJO SIMPLE

| REF. | MEASURES / MESURES / MEDIDAS |
|-----------|------------------------------|
| BL8900220 | 60 x 50 cm |
| BL8900230 | 80 x 50 cm |
| BL8900240 | 100 x 50 cm |
| BL8900250 | 120 X 50 cm |

100 cm BASE UNIT WITH 2 DRAWERS / 2 DOORS - TEA • 101 cm RECTO WASHBASIN • 100x50 cm SIMPLE MIRROR
MEUBLE 100 cm AVEC 2 TIROIRS / 2 PORTES - TEA • LAVABO RECTO 101 cm • MIROIR SIMPLE 100x50 cm
MUEBLE 100 cm CON 2 CAJONES / 2 PUERTAS - TEA • LAVABO RECTO 101 cm • ESPEJO SIMPLE 100x50 cm

CHECK THE TOP COVERS' FEATURES ON PAGE 23
VÉRIFIEZ LES CARACTÉRISTIQUES DES PLATEAUX SUPÉRIEURS SUR LA PAGE 23
VEE LAS ESPECIFICACIONES DE LAS TAPAS EN LA PÁGINA 23

BASE UNIT WITH TOP COVER
MEUBLE AVEC PLATEAU SUPÉRIEUR
MUEBLE CON TAPA

SUSPENDED BASE UNIT
MUEBLE SUSPENDU
MUEBLE SUSPENDIDO

| 60 | 80 | 100 | 120 | 120 |
|---|--|--|--|--|
| 2 DRAWERS / 1 DOOR 2 TIROIRS / 1 PORTE 2 CAJONES / 1 PUERTA | 2 DRAWERS / 2 DOORS 2 TIROIRS / 2 PORTES 2 CAJONES / 2 PUERTAS | 2 DRAWERS / 2 DOORS 2 TIROIRS / 2 PORTES 2 CAJONES / 1 PUERTAS | 4 DRAWERS / 2 DOORS 4 TIROIRS / 2 PORTES 4 CAJONES / 2 PUERTAS | 2 DRAWERS / 2 DOORS 2 TIROIRS / 2 PORTES 2 CAJONES / 2 PUERTAS |
| 60 45 60 | 80 45 60 | 100 45 60 | 120 45 60 | 120 45 60 |
| REF. | REF. | REF. | REF. | REF. |
| BL81400600 | BL8140700 | BL8140800 | BL8140900 | BL8141100 |
| BL8140680 | BL8140780 | BL8140880 | BL8140980 | BL8141180 |
| BL8140681 | BL8140781 | BL8140881 | BL8140981 | BL8141181 |
| BL8140685 | BL8140785 | BL8140885 | BL8140985 | BL8141185 |
| BL8140686 | BL8140786 | BL8140886 | BL8140986 | BL8141186 |

- WHITE | BLANC | BLANCO*
- ESTEPA | ESTEPA | ESTEPA
- TAIGA | TAIGA | TAIGA
- TEA | TEA | TEA
- HERA | HERA | HERA

*Lacquered fronts | Façades laquées | Frontes lacadas



60 cm SUSPENDED BASE UNIT WITH 1 DRAWER - WHITE • 61 cm RECTO WASHBASIN • 80x60 cm LISO REVERSIBLE MIRROR
 140 cm PURE SUSPENDED COLUMN WITH 2 DOORS - WHITE
 MEUBLE SUSPENDU 60 cm AVEC 1 TIROIR - BLANC • LAVABO RECTO 61 cm • MIROIR RÉVERSIBLE LISO 80x60 cm
 COLONNE SUSPENDUE PURE 140 cm AVEC 2 PORTES - BLANC
 MUEBLE SUSPENDIDO 60 cm CON 1 CAJÓN - BLANCO • LAVABO RECTO 61 cm • ESPEJO REVERSIBLE LISO 80x60 cm
 COLUMNA SUSPENDIDA PURE 140 cm CON 2 PUERTAS - BLANCO



WHITE
BLANC
BLANCO



ESTEPA
ESTEPA
ESTEPA



TAIGA
TAIGA
TAIGA



TEA
TEA
TEA



HERA
HERA
HERA

BASE UNIT WITH **RECTO** CERAMIC WASHBASIN
 MEUBLE AVEC LAVABO **RECTO** EN CÉRAMIQUE
 MUEBLE CON LAVABO RECTO DE CERÁMICA

SUSPENDED BASE UNIT
MUEBLE SUSPENDU
 MUEBLE SUSPENDIDO



60 1 DRAWER
1 TIROIR
1 CAJÓN
60 45 45

REF.



80 1 DRAWER / 1 DOOR
1 TIROIR / 1 PORTE
1 CAJÓN / 1 PUERTA
80 45 45

REF.



100 1 DRAWER / 1 DOOR
1 TIROIR / 1 PORTE
1 CAJÓN / 1 PUERTA
100 45 45

REF.

WHITE | BLANC | BLANCO

ESTEPA | ESTEPA | ESTEPA

TAIGA | TAIGA | TAIGA

TEA | TEA | TEA

HERA | HERA | HERA

BL8001000

BL8003000

BL8005000

BL8001080

BL8003080

BL8005080

BL8001081

BL8003081

BL8005081

BL8001085

BL8003085

BL8005085

BL8001086

BL8003086

BL8005086

*Lacquered fronts | Façades laquées | Frontes lacadas



80cm SUSPENDED BASE UNIT WITH 1 DRAWER / 1 DOOR - TAIGA
 81 cm RECTO WASHBASIN · 80x50 cm SIMPLE MIRROR · ALYA LED LIGHT FIXTURE
 140 cm PURE SUSPENDED COLUMN WITH 2 DOORS - TAIGA
 MEUBLE SUSPENDU 80 cm AVEC 1 TIROIR / 1 PORTE - TAIGA
 LAVABO RECTO 81 cm · MIROIR SIMPLE 80x50 cm · APPLIQUE LED ALYA
 COLONNE SUSPENDUE PURE 140 cm AVEC 2 PORTES - TAIGA
 MUEBLE SUSPENDIDO 80 cm CON 1 CAJÓN / 1 PUERTA - TAIGA
 LAVABO RECTO 81 cm · ESPEJO SIMPLE 80x50 cm · APLIQUE LED ALYA
 COLUMNA SUSPENDIDA PURE 140 cm CON 2 PUERTAS - TAIGA

ALYA LED LIGHT FIXTURE
 APPLIQUE LED ALYA | APLIQUE LED ALYA

| REF. | LEDS | MEASURES MESURES MEDIDAS |
|------------------|------|------------------------------|
| BL5520510 | 3W | 11.7 cm |

LISO REVERSIBLE MIRROR | MIROIR
 RÉVERSIBLE LISO | ESPEJO REVERSIBLE LISO

| REF. | MEASURES MESURES MEDIDAS |
|------------------|------------------------------|
| BL8900130 | 80 x 60 cm |

SIMPLE MIRROR
 MIROIR SIMPLE | ESPEJO SIMPLE

| REF. | MEASURES MESURES MEDIDAS |
|-----------|------------------------------|
| BL8900220 | 60 x 50 cm |
| BL8900230 | 80 x 50 cm |
| BL8900240 | 100 x 50 cm |
| BL8900250 | 120 X 50 cm |



80 cm BASE UNIT WITH 1 DRAWER / 3 DOORS - WHITE
 81 cm RECTO WASHBASIN · 80x60 cm LISO REVERSIBLE MIRROR
 MEUBLE 80 cm AVEC 1 TIROIR / 3 PORTES - BLANC
 LAVABO RECTO 81 cm · MIROIR RÉVERSIBLE LISO 80x60 cm
 MUEBLE 80 cm CON 1 CAJÓN / 3 PUERTAS - BLANCO
 LAVABO RECTO 81 cm · ESPEJO REVERSIBLE LISO 80x60 cm



60 cm BASE UNIT WITH 1 DRAWER / 2 DOORS - ESTEPA
 61 cm RECTO WASHBASIN · 80x60 cm LISO REVERSIBLE MIRROR
 MEUBLE 60 cm AVEC 1 TIROIR / 2 PORTES - ESTEPA
 LAVABO RECTO 61 cm · MIROIR RÉVERSIBLE LISO 80x60 cm
 MUEBLE 60 cm CON 1 CAJÓN / 2 PUERTAS - ESTEPA
 LAVABO RECTO 61 cm · ESPEJO REVERSIBLE LISO 80x60 cm



WHITE
BLANC
BLANCO



ESTEPA
ESTEPA
ESTEPA



TAIGA
TAIGA
TAIGA



TEA
TEA
TEA



HERA
HERA
HERA

BASE UNIT WITH **RECTO** CERAMIC WASHBASIN
 MEUBLE AVEC LAVABO **RECTO** EN CÉRAMIQUE
 MUEBLE CON LAVABO RECTO DE CERÁMICA

BASE UNIT WITH FEET
 MUEBLE AVEC PIEDS
 MUEBLE CON PATAS



60 1 DRAWER / 3 DOORS
 1 TIROIR / 2 PORTES
 1 CAJÓN / 2 PUERTAS
 60 45 80

REF.



80 1 DRAWER / 3 DOORS
 1 TIROIR / 3 PORTES
 1 CAJÓN / 3 PUERTAS
 80 45 80

REF.



100 1 DRAWER / 3 DOORS
 1 TIROIR / 3 PORTES
 1 CAJÓN / 3 PUERTAS
 100 45 80

REF.

WHITE | BLANC | BLANCO

ESTEPA | ESTEPA | ESTEPA

TAIGA | TAIGA | TAIGA

TEA | TEA | TEA

HERA | HERA | HERA

BL8030000

BL8032000

BL8034000

BL8030080

BL8032080

BL8034080

BL8030081

BL8032081

BL8034081

BL8030085

BL8032085

BL8034085

BL8030086

BL8032086

BL8034086

*Lacquered fronts | Façades laquées | Frontes lacadas



soft-close
soft-close
cierre suave

80cm BASE UNIT WITH 1 DRAWER / 3 DOORS - HERA
81 cm RECTO WASHBASIN · 80x50 cm SIMPLE MIRROR · ALYA LED LIGHT FIXTURE
140 cm PURE SUSPENDED COLUMN WITH 2 DOORS - HERA
MEUBLE 80 cm AVEC 1 TIROIR / 3 PORTES - HERA
LAVABO RECTO 81 cm · MIROIR SIMPLE 80x50 cm · APPLIQUE LED ALYA
COLONNE SUSPENDUE PURE 140 cm AVEC 2 PORTES - HERA
MUEBLE 80 cm CON 1 CAJÓN / 3 PUERTAS - HERA
LAVABO RECTO 81 cm · ESPEJO SIMPLE 80x50 cm · APLIQUE LED ALYA
COLUMNA SUSPENDIDA PURE 140 cm CON 2 PUERTAS - HERA

LISO REVERSIBLE MIRROR | MIROIR
RÉVERSIBLE LISO | ESPEJO REVERSIBLE LISO

| REF. | MEASURES MESURES MEDIDAS |
|-----------|------------------------------|
| BL8900130 | 80 x 60 cm |

ALYA LED LIGHT FIXTURE
APPLIQUE LED ALYA | APLIQUE LED ALYA

| REF. | LEDS | MEASURES MESURES MEDIDAS |
|-----------|------|------------------------------|
| BL5520510 | 3W | 11.7 cm |

SIMPLE MIRROR
MIROIR SIMPLE | ESPEJO SIMPLE

| REF. | MEASURES MESURES MEDIDAS |
|-----------|------------------------------|
| BL8900220 | 60 x 50 cm |
| BL8900230 | 80 x 50 cm |
| BL8900240 | 100 x 50 cm |
| BL8900250 | 120 X 50 cm |



80cm BASE UNIT WITH 2 DOORS - HERA · 81 cm RECTO WASHBASIN · 80x50 cm SIMPLE MIRROR · 140 cm PURE SUSPENDED COLUMN WITH 2 DOORS - HERA
 MEUBLE 80 cm AVEC 2 PORTES - HERA · LAVABO RECTO 81 cm · MIROIR SIMPLE 80x50 cm · COLONNE SUSPENDUE PURE 140 cm AVEC 2 PORTES - HERA
 MUEBLE 80 cm CON 2 PUERTAS - HERA · LAVABO RECTO 81 cm · ESPEJO SIMPLE 80x50 cm · COLUMNA SUSPENDIDA PURE 140 cm CON 2 PUERTAS - HERA



WHITE
BLANC
BLANCO



ESTEPA
ESTEPA
ESTEPA



TAIGA
TAIGA
TAIGA



TEA
TEA
TEA



HERA
HERA
HERA

BASE UNIT WITH FEET
MUEBLE AVEC PIEDS
MUEBLE CON PATAS

BASE UNIT WITH RECTO CERAMIC WASHBASIN
MEUBLE AVEC LAVABO RECTO EN CERAMIQUE
MUEBLE CON LAVABO RECTO DE CERAMICA



60 2 DOORS
2 PORTES
2 PUERTAS



REF.



80 2 DOORS
2 PORTES
2 PUERTAS



REF.



100 2 DOORS
2 PORTES
2 PUERTAS



REF.

WHITE | BLANC | BLANCO*

ESTEPA | ESTEPA | ESTEPA

TAIGA | TAIGA | TAIGA

TEA | TEA | TEA

HERA | HERA | HERA

BL8035000

BL8035080

BL8035081

BL8035085

BL8035086

BL8037000

BL8037080

BL8037081

BL8037085

BL8037086

BL8039000

BL8039080

BL8039081

BL8039085

BL8039086

*Lacquered fronts | Façades laquées | Frentes lacadas

SIMPLE MIRROR
MIROIR SIMPLE | ESPEJO SIMPLE

ESPELHO SIMPLES

| REF. | MEASURES / MESURES / MEDIDAS |
|-----------|------------------------------|
| BL8900220 | 60 x 50 cm |
| BL8900230 | 80 x 50 cm |
| BL8900240 | 100 x 50 cm |
| BL8900250 | 120 X 50 cm |



140 cm PURE SUSPENDED COLUMN WITH 2 DOORS - ESTEPA
 COLONNE SUSPENDUE PURE 140 cm AVEC 2 PORTES - ESTEPA
 COLUMNA SUSPENDIDA PURE 140 cm CON 2 PUERTAS - ESTEPA



140 cm PURE SUSPENDED COLUMN WITH 2 DOORS - TEA
 COLONNE SUSPENDUE PURE 140 cm AVEC 2 PORTES - TEA
 COLUMNA SUSPENDIDA PURE 140 cm CON 2 PUERTAS - TEA



140 cm PURE SUSPENDED COLUMN WITH 2 DOORS - TAIGA
 COLONNE SUSPENDUE PURE 140 cm AVEC 2 PORTES - TAIGA
 COLUMNA SUSPENDIDA PURE 140 cm CON 2 PUERTAS - TAIGA



WHITE
BLANC
BLANCO



ESTEPA
ESTEPA
ESTEPA



TAIGA
TAIGA
TAIGA



TEA
TEA
TEA



HERA
HERA
HERA

SUSPENDED COLUMN
 COLONNE SUSPENDUE
 COLUMNA SUSPENDIDA



30 2 DOORS
2 PORTES
2 PUERTAS
24 140

REF.

| | | |
|---|--------------------------|-----------|
| ○ | WHITE BLANC BLANCO* | BL0090000 |
| ● | ESTEPA ESTEPA ESTEPA | BL0090080 |
| ● | TAIGA TAIGA TAIGA | BL0090081 |
| ● | TEA TEA TEA | BL0090085 |
| ● | HERA HERA HERA | BL0090086 |

*Lacquered fronts | Façades laquées | Frentes lacadas





mirrors *miroirs* espejos

Whether it's a large or small mirror, these elements are more than just a decoration of your bathroom. More than combining functionality and design, these items help us in our many daily routines. Choose the right mirror for your bathroom and match it with your furniture.

Qu'il s'agisse d'un grand ou d'un petit miroir, il est plus qu'une simple décoration de votre salle de bain. Ces éléments, qui combinent la fonctionnalité et le design, nous aident dans les différentes routines du matin ou du soir. Choisissez le miroir parfait pour votre salle de bain et combinez-le avec vos meubles.

Ya sean más grandes o más pequeños, los espejos son más que un simple objeto decorativo de tu espacio de baño. Estos elementos, que combinan funcionalidad y diseño, nos ayudan en las diferentes rutinas de la mañana o de la noche. Elige el mejor espejo para tu baño y combínalo con tus muebles.

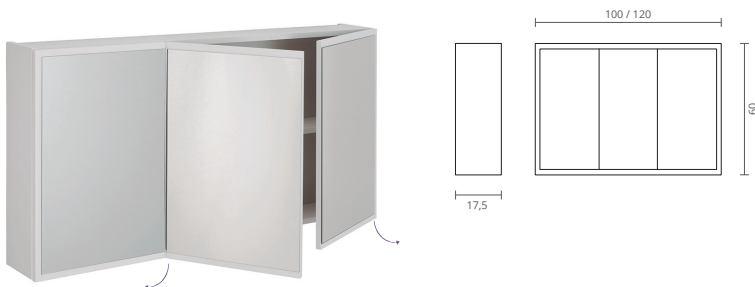
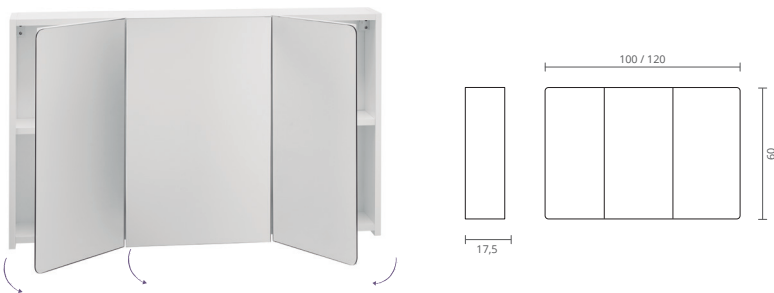

NORDIC

CABINET WITH MIRROR DOORS AND ROUNDED CORNERS
 ARMOIRE À PORTES MIROIR ET COINS RONDES
 ARMARIO CON PUERTAS ESPEJO Y CANTOS REDONDOS

| | REF. | | |
|------------------------------|-----------|-------------|----------------------------------|
| ○ WHITE BLANC BLANCO | BL0018000 | 60 x 60 cm | 2 DOORS 2 PORTES 2 PUERTAS |
| | BL0018200 | 80 x 60 cm | 2 DOORS 2 PORTES 2 PUERTAS |
| | BL0018400 | 100 x 60 cm | 3 DOORS 3 PORTES 3 PUERTAS |
| ● ESTEPA ESTEPA ESTEPA | BL0018600 | 120 x 60 cm | 3 DOORS 3 PORTES 3 PUERTAS |
| | BL0018080 | 60 x 60 cm | 2 DOORS 2 PORTES 2 PUERTAS |
| | BL0018280 | 80 x 60 cm | 2 DOORS 2 PORTES 2 PUERTAS |
| ● TAIGA TAIGA TAIGA | BL0018480 | 100 x 60 cm | 3 DOORS 3 PORTES 3 PUERTAS |
| | BL0018680 | 120 x 60 cm | 3 DOORS 3 PORTES 3 PUERTAS |
| | BL0018081 | 60 x 60 cm | 2 DOORS 2 PORTES 2 PUERTAS |
| ● TEA TEA TEA | BL0018281 | 80 x 60 cm | 2 DOORS 2 PORTES 2 PUERTAS |
| | BL0018481 | 100 x 60 cm | 3 DOORS 3 PORTES 3 PUERTAS |
| | BL0018681 | 120 x 60 cm | 3 DOORS 3 PORTES 3 PUERTAS |
| ● HERA HERA HERA | BL0018085 | 60 x 60 cm | 2 DOORS 2 PORTES 2 PUERTAS |
| | BL0018285 | 80 x 60 cm | 2 DOORS 2 PORTES 2 PUERTAS |
| | BL0018485 | 100 x 60 cm | 3 DOORS 3 PORTES 3 PUERTAS |
| ● HERA HERA HERA | BL0018685 | 120 x 60 cm | 3 DOORS 3 PORTES 3 PUERTAS |
| | BL0018086 | 60 x 60 cm | 2 DOORS 2 PORTES 2 PUERTAS |
| | BL0018286 | 80 x 60 cm | 2 DOORS 2 PORTES 2 PUERTAS |
| ● HERA HERA HERA | BL0018486 | 100 x 60 cm | 3 DOORS 3 PORTES 3 PUERTAS |
| | BL0018686 | 120 x 60 cm | 3 DOORS 3 PORTES 3 PUERTAS |

PRACTICAL

CABINET WITH MIRROR DOORS
 ARMOIRE À PORTES MIROIR
 ARMARIO CON PUERTAS ESPEJO

| | REF. | | |
|------------------------------|-----------|-------------|----------------------------------|
| ○ WHITE BLANC BLANCO | BL0016000 | 60 x 60 cm | 2 DOORS 2 PORTES 2 PUERTAS |
| | BL0016200 | 80 x 60 cm | 2 DOORS 2 PORTES 2 PUERTAS |
| | BL0016400 | 100 x 60 cm | 3 DOORS 3 PORTES 3 PUERTAS |
| ● ESTEPA ESTEPA ESTEPA | BL0016600 | 120 x 60 cm | 3 DOORS 3 PORTES 3 PUERTAS |
| | BL0016080 | 60 x 60 cm | 2 DOORS 2 PORTES 2 PUERTAS |
| | BL0016280 | 80 x 60 cm | 2 DOORS 2 PORTES 2 PUERTAS |
| ● TAIGA TAIGA TAIGA | BL0016480 | 100 x 60 cm | 3 DOORS 3 PORTES 3 PUERTAS |
| | BL0016680 | 120 x 60 cm | 3 DOORS 3 PORTES 3 PUERTAS |
| | BL0016081 | 60 x 60 cm | 2 DOORS 2 PORTES 2 PUERTAS |
| ● TEA TEA TEA | BL0016281 | 80 x 60 cm | 2 DOORS 2 PORTES 2 PUERTAS |
| | BL0016481 | 100 x 60 cm | 3 DOORS 3 PORTES 3 PUERTAS |
| | BL0016681 | 120 x 60 cm | 3 DOORS 3 PORTES 3 PUERTAS |
| ● HERA HERA HERA | BL0016085 | 60 x 60 cm | 2 DOORS 2 PORTES 2 PUERTAS |
| | BL0016285 | 80 x 60 cm | 2 DOORS 2 PORTES 2 PUERTAS |
| | BL0016485 | 100 x 60 cm | 3 DOORS 3 PORTES 3 PUERTAS |
| ● HERA HERA HERA | BL0016685 | 120 x 60 cm | 3 DOORS 3 PORTES 3 PUERTAS |
| | BL0016086 | 60 x 60 cm | 2 DOORS 2 PORTES 2 PUERTAS |
| | BL0016286 | 80 x 60 cm | 2 DOORS 2 PORTES 2 PUERTAS |
| ● HERA HERA HERA | BL0016486 | 100 x 60 cm | 3 DOORS 3 PORTES 3 PUERTAS |
| | BL0016686 | 120 x 60 cm | 3 DOORS 3 PORTES 3 PUERTAS |

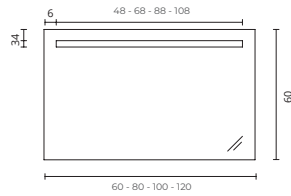

SUNNY

MIRROR WITH LED | *MIROIR AVEC LED* | ESPEJO CON LED

| REF. | | |
|------------------|--------|-------------|
| BL5007415 | 1x 8W | 60 x 60 cm |
| BL5007425 | 1x 14W | 80 x 60 cm |
| BL5007435 | 1x 18W | 100 x 60 cm |
| BL5007445 | 1x 18W | 120 x 60 cm |

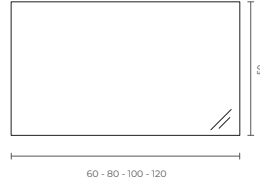
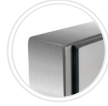

LESS

MIRROR WITH ALUMINIUM FRAME | *MIROIR AVEC CADRE EN ALUMINIUM* | ESPEJO CON MARCO DE ALUMINIO

| REF. | |
|------------------|-------------|
| BL1004510 | 60 x 50 cm |
| BL1004520 | 80 x 50 cm |
| BL1004540 | 100 x 50 cm |
| BL1004560 | 120 x 50 cm |

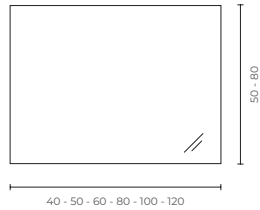

SIMPLES

MIRROR WITH GRAY FRAME | *MIROIR AVEC CADRE GRIS* | ESPEJO CON MARCO GRIS

HEIGHT 50
LA TALLE 50 | ALTURA 50

HEIGHT 80
LA TALLE 80 | ALTURA 80

| REF. | |
|------------------|-------------|
| BL8900200 | 40 x 50 cm |
| BL8900210 | 50 x 50 cm |
| BL8900220 | 60 x 50 cm |
| BL8900230 | 80 x 50 cm |
| BL8900240 | 100 x 50 cm |
| BL8900250 | 120 x 50 cm |
| BL8900400 | 40 x 80 cm |
| BL8900410 | 50 x 80 cm |
| BL8900420 | 60 x 80 cm |
| BL8900430 | 80 x 80 cm |
| BL8900440 | 100 x 80 cm |
| BL8900450 | 120 x 80 cm |



FRAME | CADRE | MARCO

| | REF. | |
|------------------------------|------------------|-------------|
| ○ WHITE BLANC BLANCO | BL0020500 | 60 x 60 cm |
| | BL0020600 | 80 x 60 cm |
| | BL0020700 | 100 x 60 cm |
| | BL0020800 | 120 x 60 cm |
| ● ESTEPA ESTEPA ESTEPA | BL0020580 | 60 x 60 cm |
| | BL0020680 | 80 x 60 cm |
| | BL0020780 | 100 x 60 cm |
| | BL0020880 | 120 x 60 cm |
| ● TAIGA TAIGA TAIGA | BL0020581 | 60 x 60 cm |
| | BL0020681 | 80 x 60 cm |
| | BL0020781 | 100 x 60 cm |
| | BL0020881 | 120 x 60 cm |
| ● TEA TEA TEA | BL0020585 | 60 x 60 cm |
| | BL0020685 | 80 x 60 cm |
| | BL0020785 | 100 x 60 cm |
| | BL0020885 | 120 x 60 cm |
| ● HERA HERA HERA | BL0020586 | 60 x 60 cm |
| | BL0020686 | 80 x 60 cm |
| | BL0020786 | 100 x 60 cm |
| | BL0020886 | 120 x 60 cm |

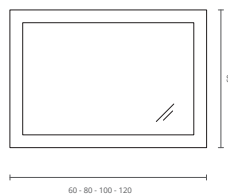

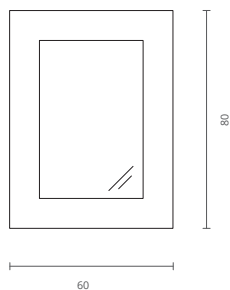

ARGENTINA

REVERSIBLE MIRROR
MIROIR RÉVERSIBLE
ESPEJO REVERSIBLE

| REF. | |
|------------------|------------|
| BL5002205 | 60 x 80 cm |

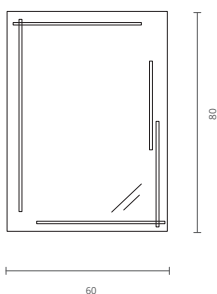

ITÁLIA

REVERSIBLE MIRROR
MIROIR RÉVERSIBLE
ESPEJO REVERSIBLE

| REF. | |
|------------------|------------|
| BL5002235 | 60 x 80 cm |

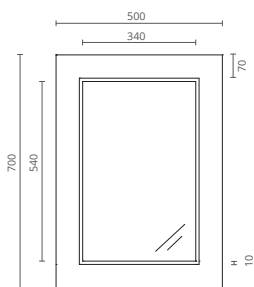

PANAMÁ

REVERSIBLE MIRROR
MIROIR RÉVERSIBLE
ESPEJO REVERSIBLE

| REF. | |
|------------------|------------|
| BL5002250 | 50 x 70 cm |

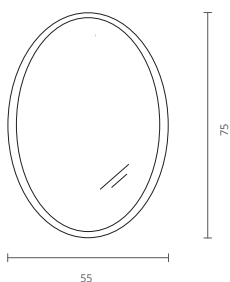

ALEMANHA

REVERSIBLE MIRROR
MIROIR RÉVERSIBLE
ESPEJO REVERSIBLE

| REF. | |
|------------------|------------|
| BL5002225 | 55 x 75 cm |



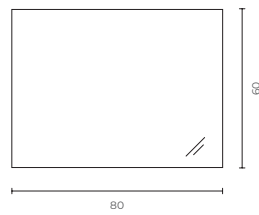

LISO

REVERSIBLE MIRROR
MIROIR RÉVERSIBLE
ESPEJO REVERSIBLE

| REF. | |
|------------------|------------|
| BL8900100 | 36 X 60 cm |
| BL8900130 | 80 x 60 cm |

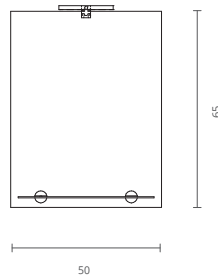

TURQUIA

MIRROR WITH LED LIGHT FIXTURE
MIROIR AVEC APPLIQUE LED
ESPEJO CON APPLIQUE LED

| REF. | |
|------------------|------------|
| BL5002002 | 50 x 65 cm |

LED LIGHT FIXTURE - 4000K CHROMED ABS - 3,5W
APPLIQUE LED - ABS CHROMÉ 4000K - 3,5W
APPLIQUE LED - ABS CROMADO 4000K - 3,5W

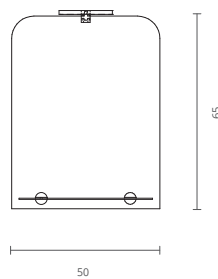

TUNÍSIA

MIRROR WITH LED LIGHT FIXTURE
MIROIR AVEC APPLIQUE LED
ESPEJO CON APPLIQUE LED

| REF. | |
|------------------|------------|
| BL5002012 | 50 x 65 cm |

LED LIGHT FIXTURE - 4000K CHROMED ABS - 3,5W
APPLIQUE LED - ABS CHROMÉ 4000K - 3,5W
APPLIQUE LED - ABS CROMADO 4000K - 3,5W

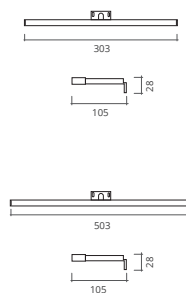

CLEAR

LED LIGHT FIXTURE WITH MULTI FITTING SUPPORT
APPLIQUE LED AVEC SUPPORT MULTI FIXATION
APPLIQUE LED CON APOYO MULTI-FIJACIÓN

| REF. | | |
|------------------|----|-------|
| BL5520000 | 6W | 30 cm |
| BL5520010 | 6W | 50 cm |

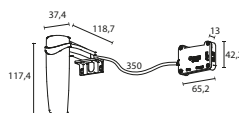

ALYA

LED LIGHT FIXTURE WITH MULTI FITTING SUPPORT
APPLIQUE LED AVEC SUPPORT MULTI FIXATION
APPLIQUE LED CON APOYO MULTI-FIJACIÓN

| REF. | | |
|------------------|----|---------|
| BL5520510 | 3W | 11.7 cm |





washbasins *lavabos* lavabos

Washbasins are bathroom essential elements. There are many washbasins with different sizes and shapes that can either be standard or built-in.

In addition to being durable, they are the perfect complement for bathroom furniture, giving it a refined and modern touch. By getting one of our washbasins, you will get elegance, functionality and a premium design.

Les lavabos sont des éléments essentiels dans une salle de bain. Il y a de nombreux lavabos de différentes formes et tailles, qui peuvent être à encastrer ou à poser. En plus d'être durables, ils sont le complément parfait pour les meubles de salle de bain, en leur donnant une touche raffinée et moderne. Avec l'un de nos lavabos, vous obtiendrez l'élégance, la fonctionnalité et un design haut de gamme.

Los lavabos son elementos imprescindibles en un baño. Hay lavabos de diferentes formas y tamaños, que pueden ser empotrables o de posar.

Además de durables, son el complemento perfecto para un mueble, dándole a tu espacio de baño un toque de refinamiento y de modernidad. Con uno de nuestros lavabos obtendrás elegancia, funcionalidad y diseño premium.

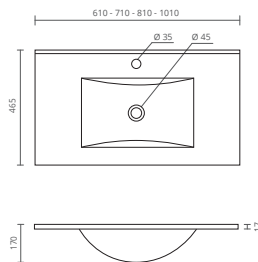

RECTO

INTEGRAL CERAMIC WASHBASIN WITH 1 BOWL
LAVABO INTÉGRAL EN CÉRAMIQUE AVEC 1 CUVE
LAVABO INTEGRAL DE CERÁMICA CON 1 CUBETA

| REF. | MEASURES MESURES MEDIDAS |
|------------------|------------------------------|
| BL6000310 | 61 x 46,5 cm |
| BL6000315 | 71 x 46,5 cm |
| BL6000320 | 81 x 46,5 cm |
| BL6000340 | 101 x 46,5 cm |

WHITE CERAMIC
CÉRAMIQUE BLANCHE
CERÁMICA BLANCA

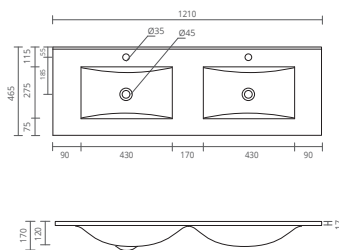

RECTO DUO

INTEGRAL CERAMIC WASHBASIN WITH 2 BOWLS
LAVABO INTÉGRAL EN CÉRAMIQUE AVEC 2 CUVES
LAVABO INTEGRAL DE CERÁMICA CON 2 CUBETAS

| REF. | MEASURES MESURES MEDIDAS |
|------------------|------------------------------|
| BL6000360 | 121 x 46,5 cm |

WHITE CERAMIC
CÉRAMIQUE BLANCHE
CERÁMICA BLANCA

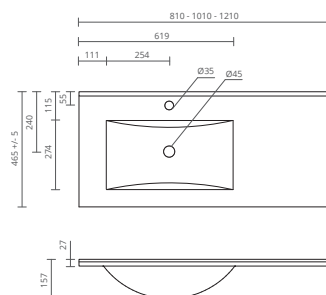

LEFT

INTEGRAL CERAMIC WASHBASIN WITH LEFT BOWL
LAVABO INTÉGRAL EN CÉRAMIQUE AVEC CUVE À LA GAUCHE
LAVABO DE CERÁMICA CON CUBETA A LA IZQUIERDA

| REF. | MEASURES MESURES MEDIDAS |
|------------------|------------------------------|
| BL6001000 | 81 x 46,5 cm |
| BL6001020 | 101 x 46,5 cm |
| BL6001030 | 121 x 46,5 cm |

WHITE CERAMIC
CÉRAMIQUE BLANCHE
CERÁMICA BLANCA

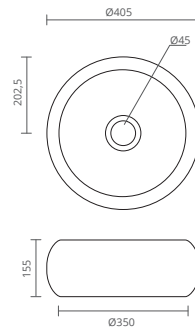

COTTON

CERAMIC COUNTERTOP WASHBASIN
VASQUE À POSER EN CÉRAMIQUE
LAVABO DE POSAR DE CERÁMICA

| REF. | MEASURES MESURES MEDIDAS |
|------------------|------------------------------|
| BL6006080 | Ø40,5 cm |

WHITE CERAMIC
CÉRAMIQUE BLANCHE
CERÁMICA BLANCA

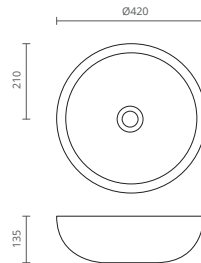

COLD

CERAMIC COUNTERTOP WASHBASIN
VASQUE À POSER EN CÉRAMIQUE
LAVABO DE POSAR DE CERÁMICA

| REF. | MEASURES MESURES MEDIDAS |
|------------------|------------------------------|
| BL6006310 | Ø42 cm |

WHITE CERAMIC
CÉRAMIQUE BLANCHE
CERÁMICA BLANCA

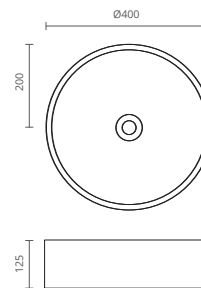

NEVADA

CERAMIC COUNTERTOP WASHBASIN
VASQUE À POSER EN CÉRAMIQUE
LAVABO DE POSAR DE CERÁMICA

| REF. | MEASURES MESURES MEDIDAS |
|------------------|------------------------------|
| BL6006330 | Ø40 cm |

WHITE CERAMIC
CÉRAMIQUE BLANCHE
CERÁMICA BLANCA

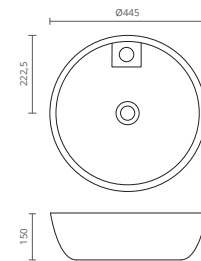

CHILL

CERAMIC COUNTERTOP WASHBASIN
VASQUE À POSER EN CÉRAMIQUE
LAVABO DE POSAR DE CERÁMICA

| REF. | MEASURES MESURES MEDIDAS |
|------------------|------------------------------|
| BL6006300 | Ø44,5 cm |

WHITE CERAMIC
CÉRAMIQUE BLANCHE
CERÁMICA BLANCA

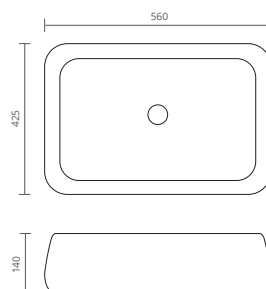

PLOW

CERAMIC COUNTERTOP WASHBASIN
VASQUE À POSER EN CÉRAMIQUE
LAVABO DE POSAR DE CERÁMICA

| REF. | MEASURES MESURES MEDIDAS |
|------------------|------------------------------|
| BL6006360 | 56 x 42,5 cm |

WHITE CERAMIC
CÉRAMIQUE BLANCHE
CERÁMICA BLANCA

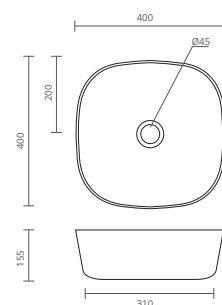

MISTIC

CERAMIC COUNTERTOP WASHBASIN
VASQUE À POSER EN CÉRAMIQUE
LAVABO DE POSAR DE CERÁMICA

| REF. | MEASURES MESURES MEDIDAS |
|------------------|------------------------------|
| BL6006095 | 40 x 40 cm |

WHITE CERAMIC
CÉRAMIQUE BLANCHE
CERÁMICA BLANCA

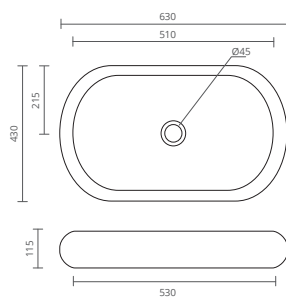

NEPAL

CERAMIC COUNTERTOP WASHBASIN
 VASQUE À POSER EN CÉRAMIQUE
 LAVABO DE POSAR DE CERÁMICA

| REF. | MEASURES / MESURES / MEDIDAS |
|------------------|------------------------------|
| BL6006085 | 63 x 43 cm |

WHITE CERAMIC
 CÉRAMIQUE BLANCHE
 CERÁMICA BLANCA

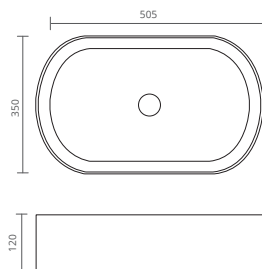

SNAP

CERAMIC COUNTERTOP WASHBASIN
 VASQUE À POSER EN CÉRAMIQUE
 LAVABO DE POSAR DE CERÁMICA

| REF. | MEASURES / MESURES / MEDIDAS |
|------------------|------------------------------|
| BL6006340 | 50,5 x 35 cm |

WHITE CERAMIC
 CÉRAMIQUE BLANCHE
 CERÁMICA BLANCA

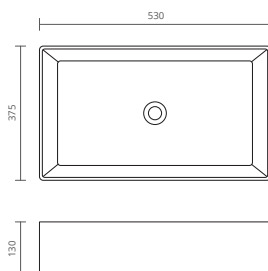

TUNDRA

CERAMIC COUNTERTOP WASHBASIN
 VASQUE À POSER EN CÉRAMIQUE
 LAVABO DE POSAR DE CERÁMICA

| REF. | MEASURES / MESURES / MEDIDAS |
|------------------|------------------------------|
| BL6006355 | 53 x 37,5 cm |

WHITE CERAMIC
 CÉRAMIQUE BLANCHE
 CERÁMICA BLANCA

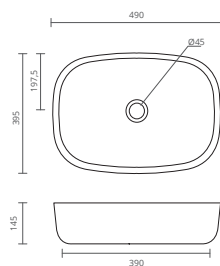

FROST

CERAMIC COUNTERTOP WASHBASIN
 VASQUE À POSER EN CÉRAMIQUE
 LAVABO DE POSAR DE CERÁMICA

| REF. | MEASURES / MESURES / MEDIDAS |
|------------------|------------------------------|
| BL6006090 | 49 x 39,5 cm |

WHITE CERAMIC
 CÉRAMIQUE BLANCHE
 CERÁMICA BLANCA

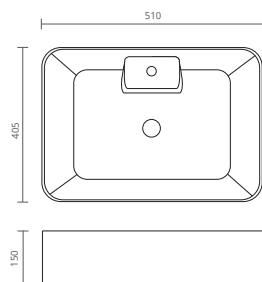

SLUSH

CERAMIC COUNTERTOP WASHBASIN
 VASQUE À POSER EN CÉRAMIQUE
 LAVABO DE POSAR DE CERÁMICA

| REF. | MEASURES / MESURES / MEDIDAS |
|------------------|------------------------------|
| BL6006335 | 51 x 40,5 cm |

WHITE CERAMIC
 CÉRAMIQUE BLANCHE
 CERÁMICA BLANCA

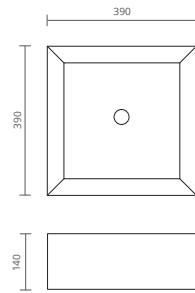

BOREAL

CERAMIC COUNTERTOP WASHBASIN
 VASQUE À POSER EN CÉRAMIQUE
 LAVABO DE POSAR DE CERÁMICA

| REF. | MEASURES MESURES MEDIDAS |
|------------------|------------------------------|
| BL6006345 | 39 x 39 cm |

WHITE CERAMIC
 CÉRAMIQUE BLANCHE
 CERÁMICA BLANCA

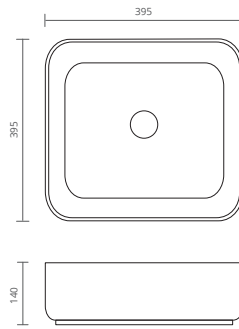

MELT

CERAMIC COUNTERTOP WASHBASIN
 VASQUE À POSER EN CÉRAMIQUE
 LAVABO DE POSAR DE CERÁMICA

| REF. | MEASURES MESURES MEDIDAS |
|------------------|------------------------------|
| BL6006350 | 39,5 x 39,5 cm |

WHITE CERAMIC
 CÉRAMIQUE BLANCHE
 CERÁMICA BLANCA

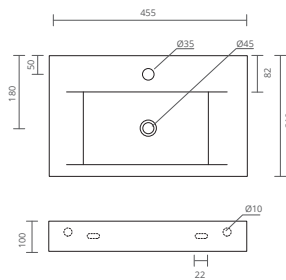

ÁRTICO

CERAMIC COUNTERTOP WASHBASIN
 VASQUE À POSER EN CÉRAMIQUE
 LAVABO DE POSAR DE CERÁMICA

| REF. | MEASURES MESURES MEDIDAS |
|------------------|------------------------------|
| BL6006000 | 45,5 x 31 cm |

WHITE CERAMIC
 CÉRAMIQUE BLANCHE
 CERÁMICA BLANCA

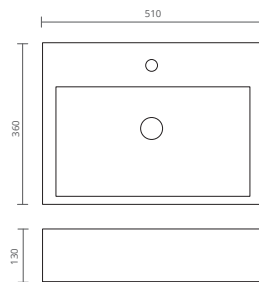

FRESH

CERAMIC COUNTERTOP WASHBASIN
 VASQUE À POSER EN CÉRAMIQUE
 LAVABO DE POSAR DE CERÁMICA

| REF. | MEASURES MESURES MEDIDAS |
|------------------|------------------------------|
| BL6006060 | 52 x 36 cm |

WHITE CERAMIC
 CÉRAMIQUE BLANCHE
 CERÁMICA BLANCA

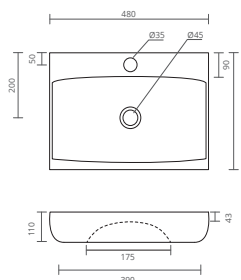

CLOUD

CERAMIC COUNTERTOP WASHBASIN
 VASQUE À POSER EN CÉRAMIQUE
 LAVABO DE POSAR DE CERÁMICA

| REF. | MEASURES MESURES MEDIDAS |
|------------------|------------------------------|
| BL6006140 | 48 x 33 cm |

WHITE CERAMIC
 CÉRAMIQUE BLANCHE
 CERÁMICA BLANCA



taps robinets grifos

Bathroom or kitchen taps – You will find our many different tap models, all of them assuring Ctesi's high-quality seal. Choose a high-quality tap from our range that suits your bathroom's style.

Robinets de salle de bains ou de cuisine - Vous trouverez différents modèles de robinets dans notre gamme, mais tous garantissent la qualité Ctesi. Choisissez nos robinets de haute qualité qui conviennent le mieux au style de votre salle de bains.

Grifería de baño o de cocina – Encontrarás diferentes modelos de grifos en nuestra gama, pero todos garanten la calidad Ctesi. Elige nuestros grifos de alta calidad que mejor se adaptan al estilo de tu baño.

TRIVIAL COLLECTION

ctesi

The **Spirit** tap features light and delicate lines, reflecting the spirit of life in your bathroom space.

With balanced proportions between its' straight lines, which disappear in smooth curves, the Spirit tap ends up bringing elegance and modernity to your bathroom space.

Le robinet Spirit présente des lignes légères et délicates, reflétant l'esprit de vie dans votre salle de bains.

Avec des proportions équilibrées entre ses lignes droites, qui disparaissent en courbes délicates, le robinet Spirit finit ajoute élégance et modernité à votre salle de bains.

El grifo **Spirit** presenta líneas ligeras y delicadas, que reflejan el espíritu de la vida en tu espacio de baño.

Con proporciones equilibradas entre líneas rectas, que se diluyen en suaves curvas, el grifo Spirit aporta elegancia y modernidad a tu espacio de baño.

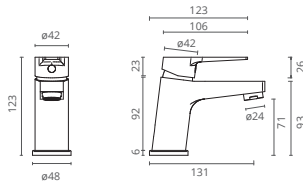

BASIN SINGLE LEVER MIXER MITIGEUR LAVABO MEZCLADOR LAVABO

REF. _____

CT2009200 SIMPLE | SIMPLE | SIMPLE

CT2009201 WITH CLICK WASTE VALVE
AVEC VIDAGE CLICK
CON DESAGÜE CLICK



CHROMED
CHROME
CROMADO

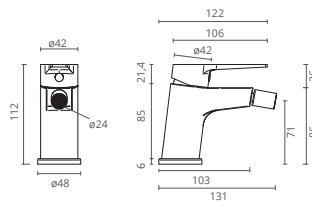

BIDET SINGLE LEVER MIXER MITIGEUR BIDET MEZCLADOR BIDÉ

REF. _____

CT2009220 SIMPLE | SIMPLE | SIMPLE

CT2009221 WITH CLICK WASTE VALVE
AVEC VIDAGE CLICK
CON DESAGÜE CLICK



CHROMED
CHROME
CROMADO

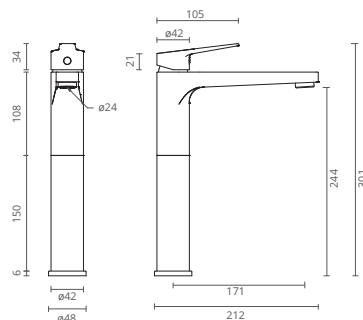

TALL BASIN SINGLE LEVER MIXER MITIGEUR LAVABO HAUT MEZCLADOR LAVABO ALTO

REF. _____

CT2009210 SIMPLE | SIMPLE | SIMPLE

CT2009211 WITH CLICK WASTE VALVE
AVEC VIDAGE CLICK
CON DESAGÜE CLICK



CHROMED
CHROME
CROMADO

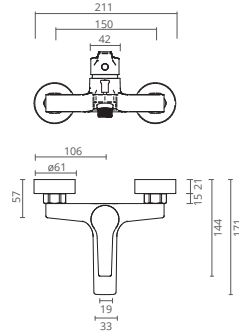

BATH SINGLE LEVER MIXER
 MITIGEUR DE BAIGNOIRE
 MEZCLADOR DE BAÑERA

REF. _____

CT2009230 SIMPLE | SIMPLE | SIMPLE

CHROMED
 CHROME
 CROMADO

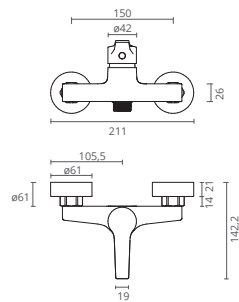

SHOWER SINGLE LEVER MIXER
 MITIGEUR DE DOUCHE
 MEZCLADOR DE DUCHA

REF. _____

CT2009240 ABS ACCESSORIES KIT + SHOWER HOSE
 KIT ACCESSOIRES EN ABS + FLEXIBLE DE DOUCHE
 SET ACCESORIOS EN ABS + FLEXIBLE DE DUCHA

CHROMED
 CHROME
 CROMADO

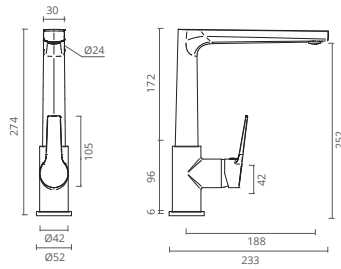

SINK SINGLE LEVER MIXER
 MITIGEUR D'ÉVIER
 MEZCLADOR DE FREGADERO

REF. _____

CT2009250 HIGH SPOUT - CAST
 BEC HAUT - FONT
 CAÑO ALTO - FUNDIDO

CHROMED
 CHROME
 CROMADO

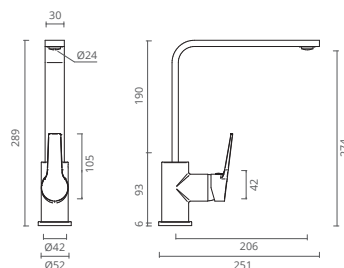

SINK SINGLE LEVER MIXER
 MITIGEUR D'ÉVIER
 MEZCLADOR DE FREGADERO

REF. _____

CT2009260 HIGH SPOUT - RECTANGULAR
 BEC HAUT - RECTANGULAIRE
 CAÑO ALTO - RECTANGULAR

CHROMED
 CHROME
 CROMADO

TRIVIAL COLLECTION

ctesi

Target is a smart choice for those who seek to combine simplicity and functionality in a very practical option. This tap's elegance and daily performance will leave you surprised.

Target est un choix intelligent pour ceux qui cherchent à combiner la simplicité et la fonctionnalité dans une option très pratique. L'élégance et les performances quotidiennes de ce robinet vous surprendront.

Target es una opción inteligente para aquellos que buscan combinar simplicidad y funcionalidad en una opción muy práctica, cuya elegancia y desempeño en el día a día te sorprenderá.

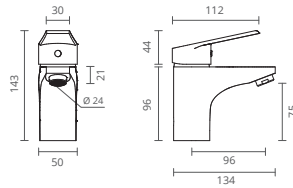

BASIN SINGLE LEVER MIXER
MITIGEUR LAVABO
MEZCLADOR LAVABO

| | |
|------------------|--|
| REF. | |
| CT2007300 | SIMPLE SIMPLE SIMPLE |
| CT2007301 | WITH CLICK WASTE VALVE AVEC VIDAGE CLICK CON DESAGÜE CLICK |

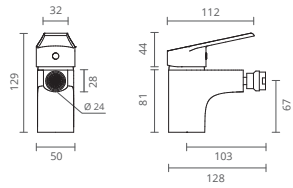

BIDET SINGLE LEVER MIXER
MITIGEUR BIDET
MEZCLADOR BIDÉ

| | |
|------------------|--|
| REF. | |
| CT2007310 | SIMPLE SIMPLE SIMPLE |
| CT2007311 | WITH CLICK WASTE VALVE AVEC VIDAGE CLICK CON DESAGÜE CLICK |

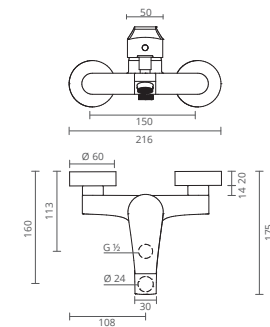

BATH SINGLE LEVER MIXER
MITIGEUR DE BAINOIRE
MEZCLADOR DE BAÑERA

| | |
|------------------|---|
| REF. | |
| CT2007320 | ABS ACCESSORIES KIT + SHOWER HOSE KIT ACCESSOIRES EN ABS + FLEXIBLE DE DOUCHE SET ACCESORIOS EN ABS + FLEXIBLE DE DUCHA |

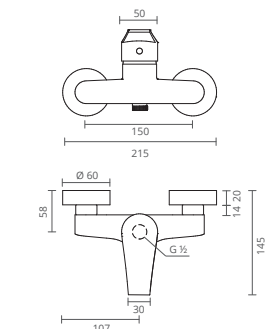

SHOWER SINGLE LEVER MIXER
MITIGEUR DE DOUCHE
MEZCLADOR DE DUCHA

| | |
|------------------|---|
| REF. | |
| CT2007330 | ABS ACCESSORIES KIT + SHOWER HOSE KIT ACCESSOIRES EN ABS + FLEXIBLE DE DOUCHE SET ACCESORIOS EN ABS + FLEXIBLE DE DUCHA |



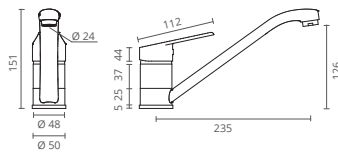

SINK SINGLE LEVER MIXER
MITIGEUR D'ÉVIER
MEZCLADOR DE FREGADERO

REF. _____

CT2007340 HIGH SPOUT | *BEC HAUT* | CAÑO ALTO

CHROMED
 CHROME
 CROMADO

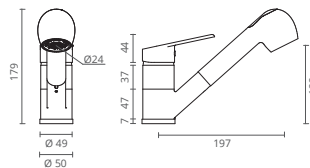

SINK SINGLE LEVER MIXER
MITIGEUR D'ÉVIER
MEZCLADOR DE FREGADERO

REF. _____

CT2007342 LOW SPOUT WITH SHOWER
BEC BAS AVEC DOUCHETTE
 CAÑO BAJO CON DUCHA

CHROMED
 CHROME
 CROMADO

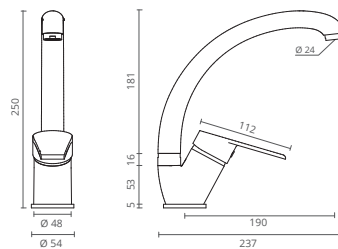

SINK SINGLE LEVER MIXER
MITIGEUR D'ÉVIER
MEZCLADOR DE FREGADERO

REF. _____

CT2007345 HIGH SPOUT | *BEC HAUT* | CAÑO ALTO

CHROMED
 CHROME
 CROMADO

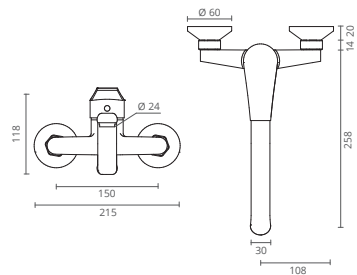

WALL-MOUNTED SINK SINGLE LEVER MIXER
MITIGEUR D'ÉVIER MURAL
MEZCLADOR MURAL DE FREGADERO

REF. _____

CT2007350 LOW SPOUT
BEC INFÉRIEURE | CAÑO INFERIOR

CHROMED
 CHROME
 CROMADO

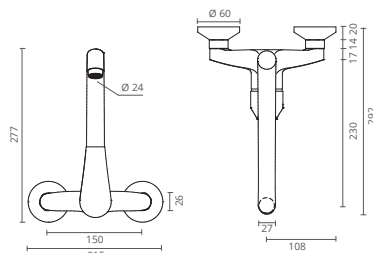

WALL-MOUNTED SINK SINGLE LEVER MIXER
MITIGEUR D'ÉVIER MURAL
MEZCLADOR MURAL DE FREGADERO

REF. _____

CT2007355 HIGH SPOUT
BEC SUPÉRIEURE | CAÑO SUPERIOR

CHROMED
 CHROME
 CROMADO

ctesi

Goal catches the eye for its simplicity, recovering all the essence of a tap that stands out for its resistance and durability.

Le modèle **Goal** attire l'attention par sa simplicité, récupérant toute l'essence d'un robinet qui se distingue par sa résistance et par sa durabilité.

El modelo Goal se destaca por su simplicidad, recuperando toda la esencia de un grifo que se diferencia por su resistencia y durabilidad.

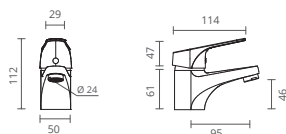

BASIN SINGLE LEVER MIXER
MITIGEUR LAVABO
MEZCLADOR LAVABO

| REF. | |
|------------------|--|
| CT2007100 | SIMPLE SIMPLE SIMPLE |
| CT2007101 | WITH CLICK WASTE VALVE AVEC VIDAGE CLICK CON DESAGÜE CLICK |



CHROMED
CHROME
CROMADO

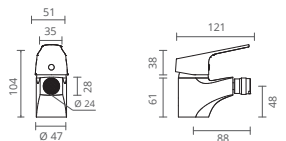

BIDET SINGLE LEVER MIXER
MITIGEUR BIDET
MEZCLADOR BIDÉ

| REF. | |
|------------------|--|
| CT2007110 | SIMPLE SIMPLE SIMPLE |
| CT2007111 | WITH CLICK WASTE VALVE AVEC VIDAGE CLICK CON DESAGÜE CLICK |



CHROMED
CHROME
CROMADO

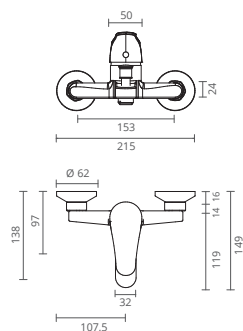

BATH SINGLE LEVER MIXER
MITIGEUR DE BAIGNOIRE
MEZCLADOR DE BAÑERA

| REF. | |
|------------------|---|
| CT2007120 | ABS ACCESSORIES KIT + SHOWER HOSE KIT ACCESSOIRES EN ABS + FLEXIBLE DE DOUCHE SET ACCESORIOS EN ABS + FLEXIBLE DE DUCHA |



CHROMED
CHROME
CROMADO

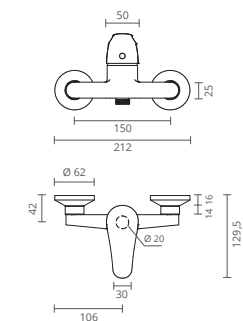

SHOWER SINGLE LEVER MIXER
MITIGEUR DE DOUCHE
MEZCLADOR DE DUCHA

| REF. | |
|------------------|---|
| CT2007130 | ABS ACCESSORIES KIT + SHOWER HOSE KIT ACCESSOIRES EN ABS + FLEXIBLE DE DOUCHE SET ACCESORIOS EN ABS + FLEXIBLE DE DUCHA |



CHROMED
CHROME
CROMADO

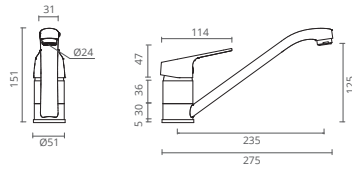

SINK SINGLE LEVER MIXER
 MITIGEUR D'ÉVIER
 MEZCLADOR DE FREGADERO

| REF. |
|---|
| CT2007140 LOW SPOUT <i>BEC BAS</i> CAÑO BAJO |

CHROMED
 CHROME
 CROMADO

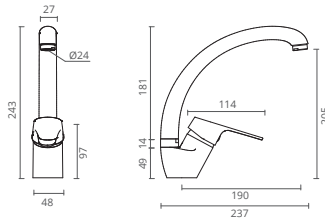

SINK SINGLE LEVER MIXER
 MITIGEUR D'ÉVIER
 MEZCLADOR DE FREGADERO

| REF. |
|---|
| CT2007145 HIGH SPOUT <i>BEC HAUT</i> CAÑO ALTO |

CHROMED
 CHROME
 CROMADO

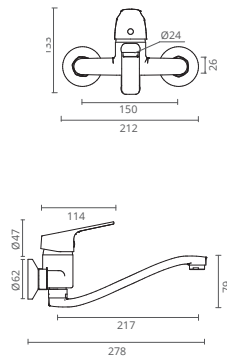

WALL-MOUNTED SINK SINGLE LEVER MIXER
 MITIGEUR D'ÉVIER MURAL
 MEZCLADOR MURAL DE FREGADERO

| REF. |
|---|
| CT2007150 LOW SPOUT <i>BEC INFÉRIEURE</i> CAÑO INFERIOR |

CHROMED
 CHROME
 CROMADO

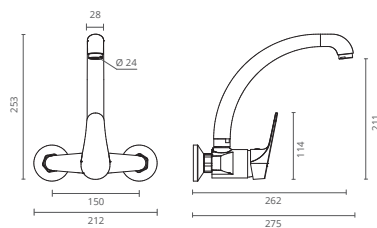

WALL-MOUNTED SINK SINGLE LEVER MIXER
 MITIGEUR D'ÉVIER MURAL
 MEZCLADOR MURAL DE FREGADERO

| REF. |
|--|
| CT2007155 HIGH SPOUT <i>BEC SUPÉRIEURE</i> CAÑO SUPERIOR |

CHROMED
 CHROME
 CROMADO

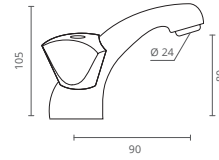

TWO-HANDLE BASIN MIXER
MÉLANGEUR LAVABO
MEZCLADOR BIMANDO LAVABO

REF.

CT2020300 SIMPLE | SIMPLE | SIMPLE

CHROMED
 CHROME
 CROMADO

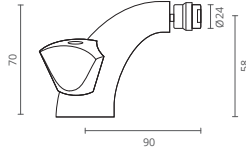

TWO-HANDLE BIDET MIXER
MÉLANGEUR BIDET
MEZCLADOR BIMANDO BIDÉ

REF.

CT2020310 SIMPLE | SIMPLE | SIMPLE

CHROMED
 CHROME
 CROMADO

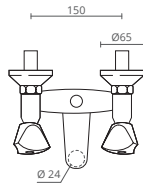

TWO-HANDLE BATH MIXER
MÉLANGEUR BAIGNOIRE
MEZCLADOR BIMANDO BAÑERA

REF.

CT2020320 ABS ACCESSORIES KIT + SHOWER HOSE
 KIT ACCESSOIRES EN ABS + FLEXIBLE DE DOUCHE
 SET ACCESORIOS EN ABS + FLEXIBLE DE DUCHA

CHROMED
 CHROME
 CROMADO

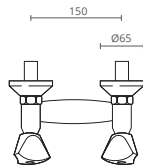

TWO-HANDLE SHOWER MIXER
MÉLANGEUR DOUCHE
MEZCLADOR BIMANDO DUCHA

REF.

CT2020330 ABS ACCESSORIES KIT + SHOWER HOSE
 KIT ACCESSOIRES EN ABS + FLEXIBLE DE DOUCHE
 SET ACCESORIOS EN ABS + FLEXIBLE DE DUCHA

CHROMED
 CHROME
 CROMADO

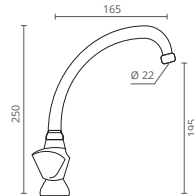

TWO-HANDLE SINK MIXER
MÉLANGEUR D'ÉVIER
MEZCLADOR BIMANDO FREGADERO

REF.

CT2020340 HIGH SPOUT | BEC HAUT | CAÑO ALTO

CHROMED
 CHROME
 CROMADO

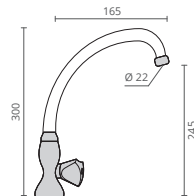

SINK TAP
ROBINET D'ÉVIER
GRIFO DE FREGADERO

REF.

CT2020360 ROTATING HIGH SPOUT
 BEC HAUT ROTATIF
 CAÑO ALTO GIRATORIO

CHROMED
 CHROME
 CROMADO

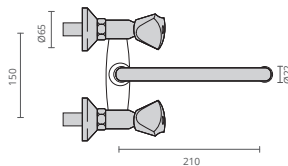

TWO-HANDLE WALL-MOUNTED HANDLE MIXER
MÉLANGEUR D'ÉVIER MURAL
MEZCLADOR BIMANDO MURAL FREGADERO

REF.

CT2020345 HIGH SPOUT
 BEC SUPÉRIEURE | CAÑO SUPERIOR

CHROMED
 CHROME
 CROMADO

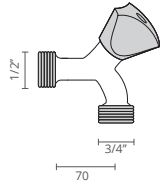

WASHING MACHINE TAP
ROBINET MACHINE À LAVER
GRIFO LAVADORA

REF.

CT2020365 SIMPLE | *SIMPLE* | SIMPLE

CHROMED
 CHROME
 CROMADO

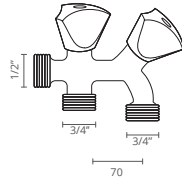

WASHING MACHINE TAP
ROBINET MACHINE À LAVER
GRIFO LAVADORA

REF.

CT2020367 DOUBLE | *DOUBLE* | DOBLE

CHROMED
 CHROME
 CROMADO

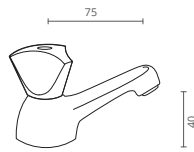

BASIN PILLAR TAP WITH AERATOR
ROBINET LAVABO AVEC AÉRATEUR
GRIFO LAVABO CON AIREADOR

REF.

CT2020352 COLD / HOT
 FROIDE / CHAUDE
 FRÍA / CALIENTE

CHROMED
 CHROME
 CROMADO

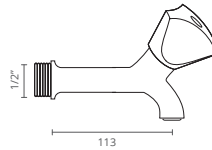

WALL-MOUNTED SINK TAP
ROBINET D'ÉVIER MURAL
GRIFO MURAL FREGADERO

REF.

MEASURES | *MESURES* | MEDIDAS

CT2020355

1/2"

CHROMED
 CHROME
 CROMADO

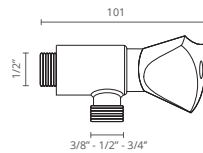

ANGLE VALVE PILLAR TAP
ROBINET D'ÉQUERRE
LLAVE ESCUADRA

REF.

MEASURES | *MESURES* | MEDIDAS

CT2020370

1/2" x 3/8"

CT2020371

1/2" x 1/2"

CT2020372

1/2" x 3/4"

CHROMED
 CHROME
 CROMADO

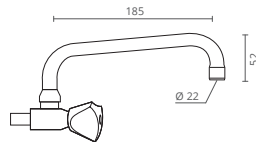

ANGLE VALVE PILLAR TAP
ROBINET D'ÉQUERRE
LLAVE ESCUADRA

REF.

CT2020375 HIGH SPOUT
 BEC SUPÉRIEURE | CAÑO SUPERIOR

CHROMED
 CHROME
 CROMADO

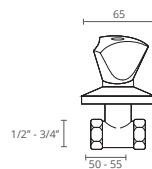

STOP VALVE
ROBINET D'ARRÊT
LLAVE DE PASO

REF.

MEASURES | *MESURES* | MEDIDAS

CT2020380

1/2"

CT2020381

3/4"

CHROMED
 CHROME
 CROMADO

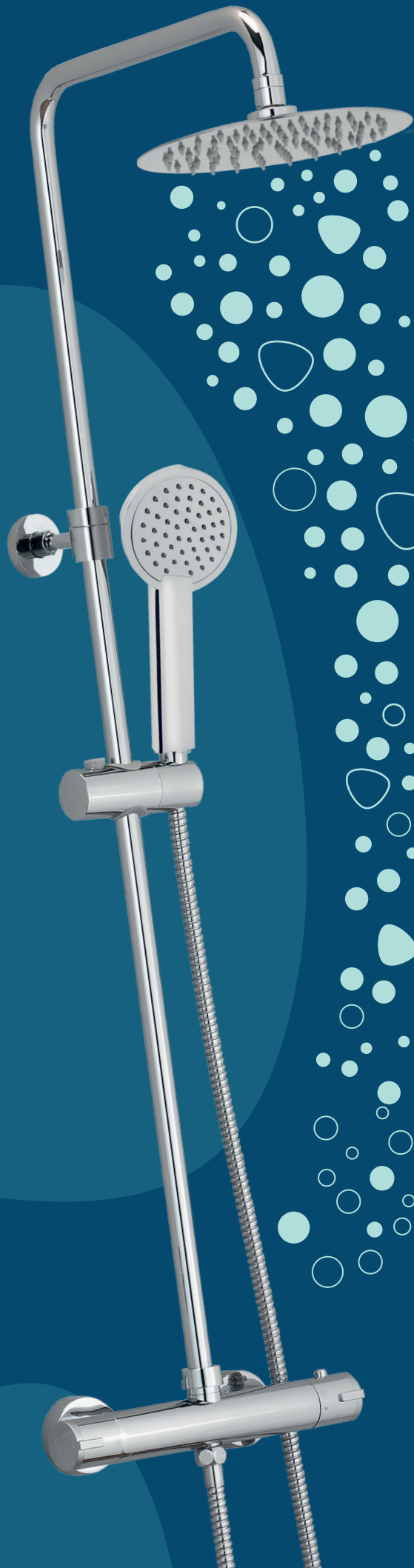

shower columns *colonnes de douche* columnas de ducha

Is there anything better than a hot shower? For that, you must choose a good shower column. With our wide range of shower columns, you will find comfort, versatility and functionality.

Choose the best column for your bathroom and turn it into a true zen space.

Y a-t-il quelque chose de mieux qu'une douche chaude? Mais pour pouvoir en profiter, il faut choisir une bonne colonne de douche.

Avec notre large gamme de colonnes de douche, vous trouverez tout le confort, la versatilité et la fonctionnalité.

¿Habrá algo mejor que una ducha caliente? Pero para eso, es fundamental elegir una buena columna de ducha. Con la gama que te presentamos, encontrarás comodidad, versatilidad y funcionalidad.

Elige la mejor columna para tu espacio de baño y conviértelo en un verdadero espacio de bienestar.

THERMO SENSE



- Extensible chrome column
- Stainless steel fixed shower
- Thermostatic mixer
- Hand shower
- 1,5m chrome shower hose
- *Colonne chromée extensible*
- *Pommeau de douche fixe en acier inoxydable*
- *Mélangeur Thermostatique*
- *Douchette à main*
- *Flexible de douche 1,50 m*
- Columna cromada extensible
- Rociador fijo en acero inoxidable
- Mezclador termostático
- Ducha de mano
- Flexible de ducha 1,50 m



EASY CLEANING | NETTOYAGE FACILE | LIMPIEZA FÁCIL

Anti-limescale system that simplifies head or hand shower limescale removal. *Système anti-calcaire qui facilite l'élimination des dépôts de calcaire dans le pommeau de douche.*

Sistema anti-caliza que facilita la eliminación de cal en la ducha.

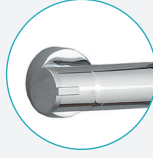

DIVERTER | INVERSEUR | DESVIADOR

Simple and intuitive diverter inside the water's opening and closing handle, allowing you to easily choose between head or hand shower, making the selection process even easier.

Inverseur simple et intuitif à l'intérieur de la poignée d'ouverture et de fermeture de l'eau, ce qui vous permet de choisir facilement entre le pommeau de douche ou la douchette à main, rendant le processus de sélection encore plus facile.

Simple e intuitivo, dentro de la apertura del agua y asa de cierre, lo que permite fácilmente elegir entre ducha de mano o rociador, simplificando tu baño.

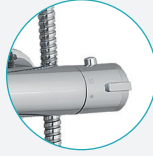

TEMPERATURE BLOCK

BLOQUEUR DE TEMPÉRATURE BLOQUEO DE LA TEMPERATURA

Safety mechanism that maintains the temperature at 38°C, preventing burns. *Mécanisme de sécurité qui maintient une température constante de 38°C, empêchant des brûlures.*

Mecanismo de seguridad que mantiene una temperatura constante de 38°C, evitando quemaduras.

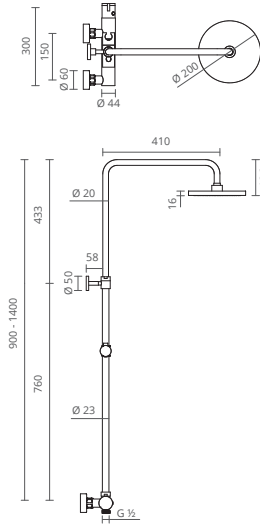

- Extensible chrome column
- ABS shower support
- Stainless steel fixed shower
- ABS hand shower
- 1,50 m shower hose
- Thermostatic shower with diverter

- *Colonne chromée extensible*
- *Support de douche en ABS*
- *Pommeau de douche fixe en acier inoxydable*
- *Douchette à main en ABS*
- *Flexible de douche 1,50 m*
- *Douche thermostatique avec inverseur*

- Columna cromada extensible
- Soporte de ducha en ABS
- Rociador fijo en acero inoxidable
- Ducha de mano en ABS
- Flexible de ducha 1,50 m
- Mezclador termostático con desviador

ROUND THERMO SENSE THERMOSTATIC SHOWER COLUMN COLONNE DE DOUCHE THERMOSTATIQUE COLUMNAS DE DUCHA THERMOSTÁTICA

| REF. | |
|-----------|---|
| CT2400500 | WITH STAINLESS STEEL FIXED SHOWER AVEC POMMEAU DE DOUCHE FIXE EN ACIER INOXYDABLE CON ROCIADOR Fijo EN ACERO INOXIDABLE |

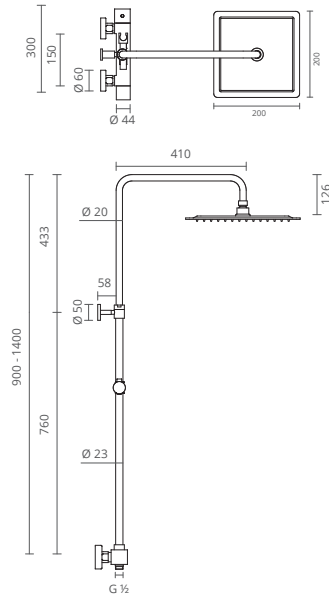

- Extensible chrome column
- ABS shower support
- Stainless steel fixed shower
- ABS hand shower
- 1,50 m shower hose
- Thermostatic shower with diverter

- *Colonne chromée extensible*
- *Support de douche en ABS*
- *Pommeau de douche fixe en acier inoxydable*
- *Douchette à main en ABS*
- *Flexible de douche 1,50 m*
- *Douche thermostatique avec inverseur*

- Columna cromada extensible
- Soporte de ducha en ABS
- Rociador fijo en acero inoxidable
- Ducha de mano en ABS
- Flexible de ducha 1,50 m
- Mezclador termostático con desviador

SQUARE THERMO SENSE THERMOSTATIC SHOWER COLUMN COLONNE DE DOUCHE THERMOSTATIQUE COLUMNAS DE DUCHA THERMOSTÁTICA

| REF. | |
|-----------|---|
| CT2400700 | WITH STAINLESS STEEL FIXED SHOWER AVEC POMMEAU DE DOUCHE FIXE EN ACIER INOXYDABLE CON ROCIADOR Fijo EN ACERO INOXIDABLE |



MONO SENSE

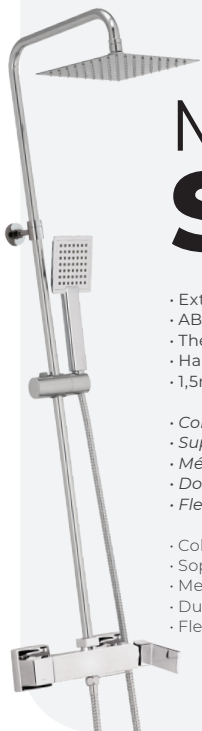

- Extensible chrome column
- ABS shower support
- Thermostatic mixer
- Hand shower
- 1,5m chrome shower hose

- *Colonne chromée extensible*
- *Support de douche en ABS*
- *Mélangeur Thermostatique*
- *Douchette à main*
- *Flexible de douche 1,50 m*

- Columna cromada extensible
- Soporte de ducha en ABS
- Mezclador termostático
- Ducha de mano
- Flexible de ducha 1,50 m

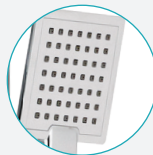

EASY CLEANING | NETTOYAGE FACILE | LIMPIEZA FÁCIL

Anti-limescale system that simplifies head or hand shower limescale removal. *Système anti-calcaire qui facilite l'élimination des dépôts de calcaire dans le pommeau de douche.*

Sistema anti-caliza que facilita la eliminación de cal en la ducha.

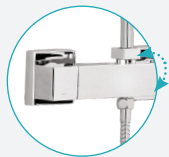

DIVERTER | INVERSEUR | DESVIADOR

Simple and intuitive diverter inside the water's opening and closing handle, allowing you to easily choose between head or hand shower, making the selection process even easier.

Inverseur simple et intuitif à l'intérieur de la poignée d'ouverture et de fermeture de l'eau, ce qui vous permet de choisir facilement entre le pommeau de douche ou la douchette à main, rendant le processus de sélection encore plus facile.

Simple e intuitivo, dentro de la apertura del agua y asa de cierre, lo que permite fácilmente elegir entre ducha de mano o rociador, simplificando tu baño.

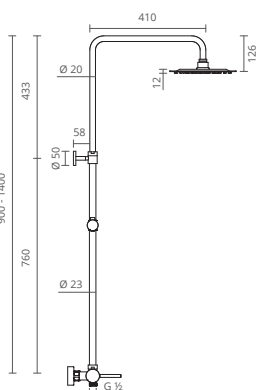
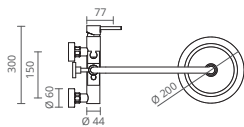

- Extensible chrome column
- ABS shower support
- Stainless steel fixed shower
- ABS hand shower
- 1,50 m shower hose
- Shower mixer with diverter

- *Colonne chromée extensible*
- *Support de douche en ABS*
- *Pommeau de douche fixe en acier inoxydable*
- *Douchette à main en ABS*
- *Flexible de douche 1,50 m*
- *Mitigeur de douche avec inverseur*

- Columna cromada extensible
- Soporte de ducha en ABS
- Rociador fijo en acero inoxidable
- Ducha de mano en ABS
- Flexible de ducha 1,50 m
- Monomando de ducha con desviador

ROUND MONO SENSE

MIXER SHOWER COLUMN
COLONNE DE DOUCHE MITIGEUR
COLUMNA DE DOUCHA MONOCOMANDO

| REF. | |
|-----------|---|
| CT2400520 | WITH STAINLESS STEEL FIXED SHOWER Avec POMMEAU DE DOUCHE FIXE EN ACIER INOXYDABLE CON ROCIADOR FIJO EN ACERO INOXIDABLE |

CHROMED
CHROME
CROMADO

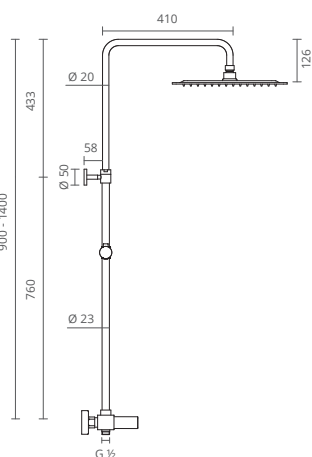
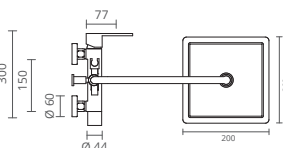

- Extensible chrome column
- ABS shower support
- Stainless steel fixed shower
- ABS hand shower
- 1,50 m shower hose
- Shower mixer with diverter

- *Colonne chromée extensible*
- *Support de douche en ABS*
- *Pommeau de douche fixe en acier inoxydable*
- *Douchette à main en ABS*
- *Flexible de douche 1,50 m*
- *Mitigeur de douche avec inverseur*

- Columna cromada extensible
- Soporte de ducha en ABS
- Rociador fijo en acero inoxidable
- Ducha de mano en ABS
- Flexible de ducha 1,50 m
- Monomando de ducha con desviador

SQUARE MONO SENSE

MIXER SHOWER COLUMN
COLONNE DE DOUCHE MITIGEUR
COLUMNA DE DOUCHA MONOCOMANDO

| REF. | |
|-----------|---|
| CT2400720 | WITH STAINLESS STEEL FIXED SHOWER Avec POMMEAU DE DOUCHE FIXE EN ACIER INOXYDABLE CON ROCIADOR FIJO EN ACERO INOXIDABLE |

CHROMED
CHROME
CROMADO

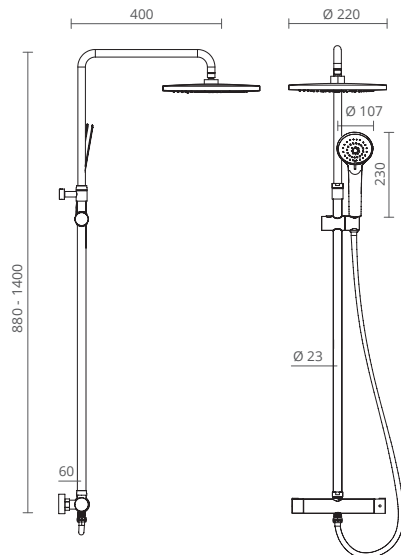

- . Extensible black column
- . ABS shower support
- . ABS fixed shower
- . ABS hand shower
- . 1,50 m shower hose
- . Thermostatic shower with diverter

- . Colonne noire extensible
- . Support de douche en ABS
- . Pommeau de douche fixe en ABS
- . Douchette à main en ABS
- . Flexible de douche 1,50 m
- . Douche thermostatique avec inverseur

- . Columna negra extensible
- . Soporte de ducha en ABS
- . Rociador fijo en ABS
- . Ducha de mano en ABS
- . Flexible de ducha 1,50 m
- . Mezclador termostático con desviador

THERMO SENSE

THERMOSTATIC SHOWER COLUMN
COLONNE DE DOUCHE THERMOSTATIQUE
COLUMNNA DE DUCHA TERMOSTÁTICA

| REF. | |
|------------------|---|
| CT2400501 | WITH ABS FIXED SHOWER AVEC POMMEAU DE DOUCHE FIXE EN ABS CON ROCIADOR Fijo EN ABS |

BLACK
NOIR
NEGRO

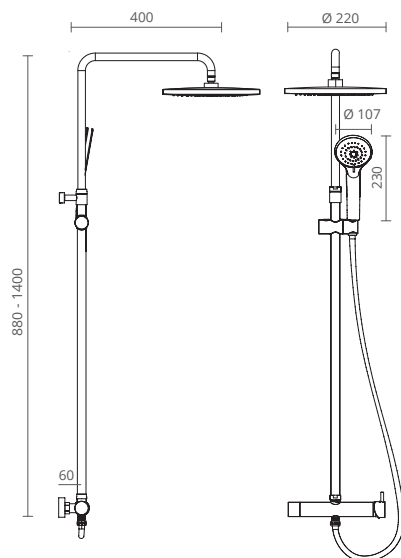

- . Extensible black column
- . ABS shower support
- . ABS fixed shower
- . ABS hand shower
- . 1,50 m shower hose
- . Shower mixer with diverter

- . Colonne noire extensible
- . Support de douche en ABS
- . Pommeau de douche fixe en ABS
- . Douchette à main en ABS
- . Flexible de douche 1,50 m
- . Mitigeur de douche avec inverseur

- . Columna negra extensible
- . Soporte de ducha en ABS
- . Rociador fijo en ABS
- . Ducha de mano en ABS
- . Flexible de ducha 1,50 m
- . Monomando de ducha con desviador

MONO SENSE

MIXER SHOWER COLUMN
COLONNE DE DOUCHE MITIGEUR
COLUMNNA DE DUCHA MONOCOMANDO

| REF. | |
|------------------|---|
| CT2400521 | WITH ABS FIXED SHOWER AVEC POMMEAU DE DOUCHE FIXE EN ABS CON ROCIADOR Fijo EN ABS |

BLACK
NOIR
NEGRO

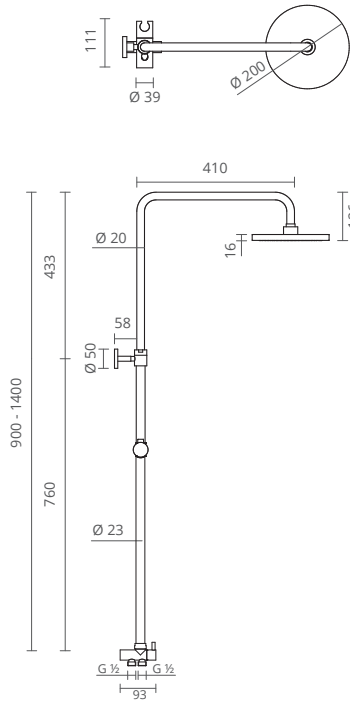

- . Extensible chrome column
- . ABS shower support
- . Stainless steel fixed shower
- . ABS hand shower
- . 1,50 m shower hose

- . *Colonne chromée extensible*
- . *Support de douche en ABS*
- . *Pommeau de douche fixe en acier inoxydable*
- . *Douchette à main en ABS*
- . *Flexible de douche 1,50 m*

- . Columna cromada extensible
- . Soporte de ducha en ABS
- . Rociador fijo en acero inoxidable
- . Ducha de mano en ABS
- . Flexible de ducha 1,50 m

ROUND UNIVERSAL

SHOWER COLUMN
COLONNE DE DOUCHE
COLUMNA DE DUCHA

| REF. | |
|------------------|---|
| CT2400650 | WITH DIVERTER AVEC INVERSEUR CON DESVIADOR |

CHROMED
CHROME
CROMADO

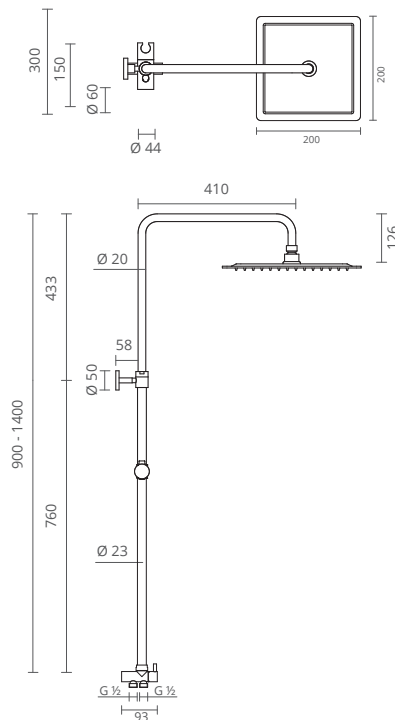

- . Extensible chrome column
- . ABS shower support
- . Stainless steel fixed shower
- . ABS hand shower
- . 1,50 m shower hose

- . *Colonne chromée extensible*
- . *Support de douche en ABS*
- . *Pommeau de douche fixe en acier inoxydable*
- . *Douchette à main en ABS*
- . *Flexible de douche 1,50 m*

- . Columna cromada extensible
- . Soporte de ducha en ABS
- . Rociador fijo en acero inoxidable
- . Ducha de mano en ABS
- . Flexible de ducha 1,50 m

SQUARE UNIVERSAL

SHOWER COLUMN
COLONNE DE DOUCHE
COLUMNA DE DUCHA

| REF. | |
|------------------|---|
| CT2400660 | WITH DIVERTER AVEC INVERSEUR CON DESVIADOR |

CHROMED
CHROME
CROMADO

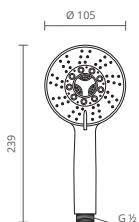

RAIN
HAND SHOWER
DOUCHETTE À MAIN
DUCHA DE MANO

| REF. |
|---|
| CT2220640 4 POSITIONS - ABS 4 FONCTIONS - ABS 4 FUNCIONES - ABS |

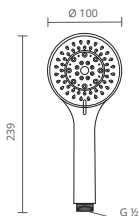

SUPRA
HAND SHOWER
DOUCHETTE À MAIN
DUCHA DE MANO

| REF. |
|--|
| CT2220620 3 POSITIONS 3 FONCTIONS 3 FUNCIONES |

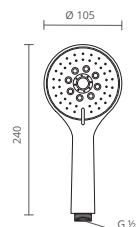

PLUVI
HAND SHOWER
DOUCHETTE À MAIN
DUCHA DE MANO

| REF. |
|--|
| CT2220670 5 POSITIONS 5 FONCTIONS 5 FUNCIONES |

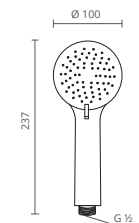

HYDRA
HAND SHOWER
DOUCHETTE À MAIN
DUCHA DE MANO

| REF. |
|--|
| CT2220710 3 POSITIONS 3 FONCTIONS 3 FUNCIONES |

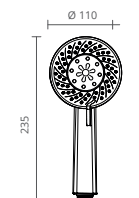

SPIRIT
HAND SHOWER
DOUCHETTE À MAIN
DUCHA DE MANO

| REF. |
|--|
| CT2220650 5 POSITIONS 5 FONCTIONS 5 FUNCIONES |

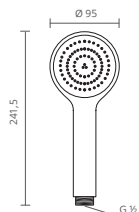

SENSE
HAND SHOWER
DOUCHETTE À MAIN
DUCHA DE MANO

| REF. |
|---|
| CT2220020 SIMPLE SIMPLE SIMPLE |



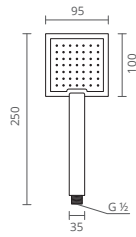

EDGE

HAND SHOWER
DOUCHETTE À MAIN
DUCHA DE MANO

REF.

CT2220030 SIMPLE | SIMPLE | SIMPLE

CHROMED
CHROME
CROMADO

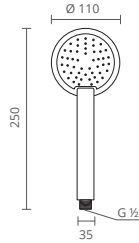

TIP

HAND SHOWER
DOUCHETTE À MAIN
DUCHA DE MANO

REF.

CT2220040 SIMPLE | SIMPLE | SIMPLE

CHROMED
CHROME
CROMADO

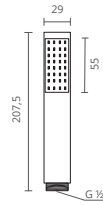

CUBE

HAND SHOWER
DOUCHETTE À MAIN
DUCHA DE MANO

REF.

CT2220200 SIMPLE | SIMPLE | SIMPLE

CHROMED
CHROME
CROMADO

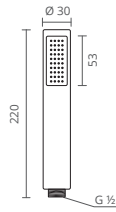

CILIN

HAND SHOWER
DOUCHETTE À MAIN
DUCHA DE MANO

REF.

CT2220120 SIMPLE | SIMPLE | SIMPLE

CHROMED
CHROME
CROMADO

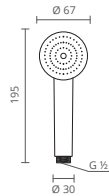

LUNA

HAND SHOWER
DOUCHETTE À MAIN
DUCHA DE MANO

REF.

CT2220005 SIMPLE | SIMPLE | SIMPLE

CHROMED
CHROME
CROMADO

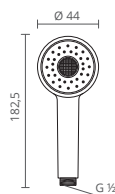

ONE

HAND SHOWER
DOUCHETTE
DUCHA

REF.

CT2222020 PULL-OUT SHOWER
RÉTRACTABLE | EXTRAÍBLE

CHROMED
CHROME
CROMADO

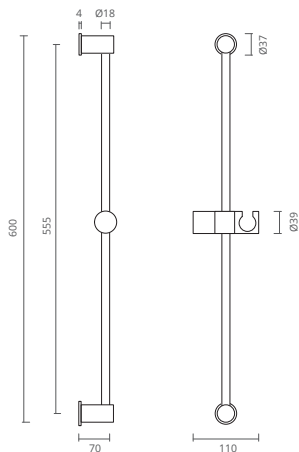

SPRING
SHOWER SLIDING RAIL
BARRE DE DOUCHE
 BARRA DE DUCHA

CHROMED
 CHROME
 CROMADO

| | |
|------------------|---|
| REF. | ABS + STAINLESS STEEL ABS + ACIER INOXYDABLE ABS + ACERO INOXIDABLE |
| CT2234020 | |

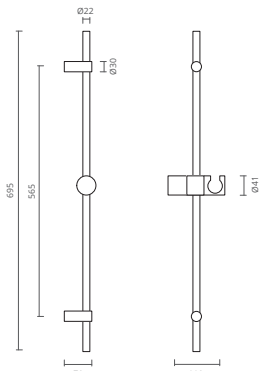

LINEA
SHOWER SLIDING RAIL
BARRE DE DOUCHE
 BARRA DE DUCHA

CHROMED
 CHROME
 CROMADO

| | |
|------------------|-----------------|
| REF. | ABS ABS ABS |
| CT2234110 | |

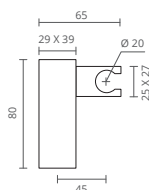

CUBE
SHOWER HOLDER
SUPPORT DE DOUCHE
 SOPORTE PARA DUCHA

CHROMED
 CHROME
 CROMADO

| | |
|------------------|-----------------|
| REF. | ABS ABS ABS |
| CT2230200 | |

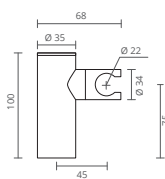

CILIN
SHOWER HOLDER
SUPPORT DE DOUCHE
 SOPORTE PARA DUCHA

CHROMED
 CHROME
 CROMADO

| | |
|------------------|-----------------|
| REF. | ABS ABS ABS |
| CT2230100 | |

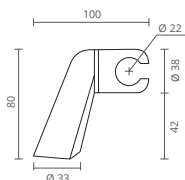

SENSE
SHOWER HOLDER
SUPPORT DE DOUCHE
 SOPORTE PARA DUCHA

CHROMED
 CHROME
 CROMADO

| | |
|------------------|-----------------|
| REF. | ABS ABS ABS |
| CT2230000 | |

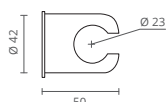

GOLF
SHOWER HOLDER
SUPPORT DE DOUCHE
 SOPORTE PARA DUCHA

CHROMED
 CHROME
 CROMADO

| | |
|------------------|-----------------------|
| REF. | METAL MÉTAL METAL |
| CT2230020 | |



FLEXIBLE HOSES FLEXIBLES DE DOUCHE FLEXIBLES DE DUCHA

EQUIPPED WITH ANTI-CORROSION SYSTEM
ÉQUIPÉS D'UN SYSTÈME ANTI-CORROSION
EQUIPADOS CON SISTEMA ANTI-CORROSIÓN

Ctesi® Giraflex shower hoses are equipped with an anti-twist system, making them the smartest choice for those who want to enjoy a pleasant and comfortable shower. Thanks to their coating, Giraflex shower hoses present a unique beauty while preventing twisting from destroying your hose or interrupting your shower.

Les flexibles de douche Giraflex Ctesi® sont équipés d'un système anti-torsion, ce qui en fait l'option la plus intelligente pour ceux qui veulent profiter d'une douche agréable et confortable. Grâce à leur revêtement, les flexibles de douche Giraflex présentent une beauté unique tout en empêchant la torsion de détruire votre flexible ou d'interrompre votre douche.

Los flexibles de ducha Giraflex de Ctesi® están equipados con un sistema anti-torsión, lo que hace que sean la opción más inteligente para los que desean una ducha agradable y llena de confort. Gracias a su revestimiento, los flexibles de ducha Giraflex tienen una belleza única al mismo tiempo que evitan que la torsión destruya tu flexible o interrumpa tu ducha.

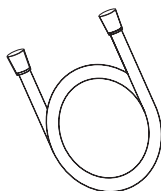

1.50 - 1.75 - 2.00 m

GIRAFLEX SHOWER HOSE FLEXIBLE DE DOUCHE FLEXIBLE DE DUCHA

| REF. | MEASURES MESURES MEDIDAS |
|-----------|------------------------------|
| CT2202150 | 1.50 m |
| CT2202175 | 1.75 m |
| CT2202200 | 2.00 m |

SILVER
ARGENT
PLATA

CHROMED
CHROMÉ
CROMADO

SHOWER HOSE WITH CONICAL NUT FLEXIBLE DE DOUCHE AVEC ÉCROU CONIQUE FLEXIBLE FLEXIBLE DE DUCHA CON TUERCA CÓNICA

| REF. | MEASURES MESURES MEDIDAS |
|-----------|------------------------------|
| CT2211125 | 1.25 m |
| CT2211150 | 1.50 m |
| CT2211175 | 1.75 m |
| CT2211200 | 2.00 m |

CHROMED
CHROMÉ
CROMADO

EXTENSIBLE SHOWER HOSE WITH CONICAL NUT FLEXIBLE DE DOUCHE EXTENSIBLE AVEC ÉCROU CONIQUE FLEXIBLE DE DUCHA EXTENSIBLE CON TUERCA CÓNICA

| REF. | MEASURES MESURES MEDIDAS |
|-----------|------------------------------|
| CT2212500 | 1.70 m » 2.20 m |

CHROMED
CHROMÉ
CROMADO

KITCHEN PULL-OUT SHOWER FLEXIBLE HOSE FLEXIBLE POUR DOUCHETTE RÉTRACTABLE DE CUISINE FLEXIBLE PARA DUCHA EXTRAÍBLE DE COCINA

| REF. | MEASURES MESURES MEDIDAS |
|-----------|------------------------------|
| CT2214125 | 1.25 m |

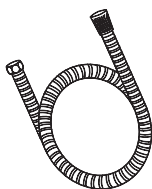
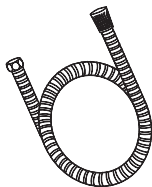

170 cm → 220 cm

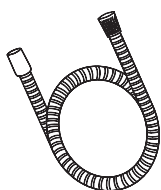
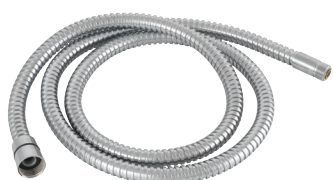

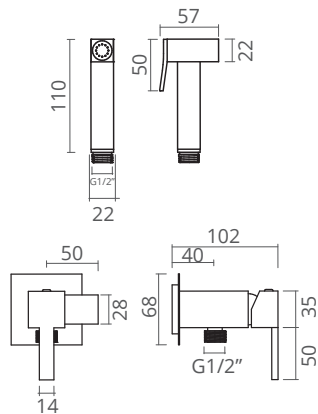

. Brass hygienic shower
 . Single lever mixer with brass shower holder
 . 120cm shower hose

*. Douchette hygiénique en laiton
 . Mitigeur intégré avec support en laiton
 . Flexible de douche 120cm*

. Ducha higiénica en latón
 . Mezclador integrado con soporte en latón
 . Flexible de ducha 120cm

SQUARE

BRASS HYGIENIC SHOWER KIT
KIT DOUCHETTE HYGIÉNIQUE EN LAITON
SET DUCHA HIGIÉNICA EN LATÓN

| REF. | |
|------------------|--|
| CT2222280 | WITH SINGLE LEVER MIXER AVEC MITIGEUR CON MEZCLADOR |

CHROMED
CHROME
CROMADO

SUPPLIED IN A CARTON BOX
FOURNI DANS UNE BOÎTE À CARTON
SUMINISTRADO EN UN EMBALAJE DE CARTÓN

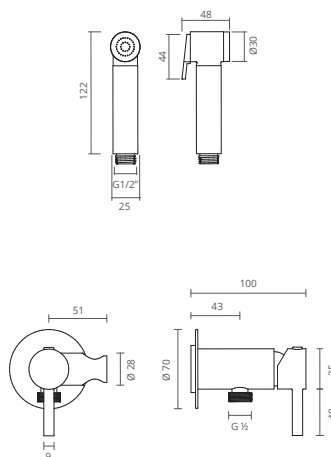

. Brass hygienic shower
 . Single lever mixer with brass shower holder
 . 120cm shower hose

*. Douchette hygiénique en laiton
 . Mitigeur intégré avec support en laiton
 . Flexible de douche 120cm*

. Ducha higiénica en latón
 . Mezclador integrado con soporte en latón
 . Flexible de ducha 120cm

TREVI

BRASS HYGIENIC SHOWER KIT
KIT DOUCHETTE HYGIÉNIQUE EN LAITON
SET DUCHA HIGIÉNICA EN LATÓN

| REF. | |
|------------------|--|
| CT2222220 | WITH SINGLE LEVER MIXER AVEC MITIGEUR CON MEZCLADOR |

CHROMED
CHROME
CROMADO

SUPPLIED IN A CARTON BOX
FOURNI DANS UNE BOÎTE À CARTON
SUMINISTRADO EN UN EMBALAJE DE CARTÓN

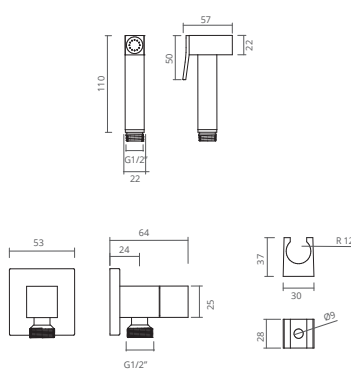

. Brass hygienic shower
 . Holder
 . 120cm shower hose
 . Angle valve pillar tap

*. Douchette hygiénique en laiton
 . Support
 . Flexible de douche 120cm
 . Robinet d'équerre*

. Ducha higiénica en latón
 . Soporte
 . Flexible de ducha 120cm
 . Llave de escuadra

SQUARE

BRASS HYGIENIC SHOWER KIT
KIT DOUCHETTE HYGIÉNIQUE EN LAITON
SET DUCHA HIGIÉNICA EN LATÓN

| REF. | |
|------------------|--|
| CT2222276 | WITH ANGLE VALVE PILLAR TAP AVEC ROBINET D'ÉQUERRE CON LLAVE DE ESCUADRA |

CHROMED
CHROME
CROMADO

SUPPLIED IN A CARTON BOX
FOURNI DANS UNE BOÎTE À CARTON
SUMINISTRADO EN UN EMBALAJE DE CARTÓN

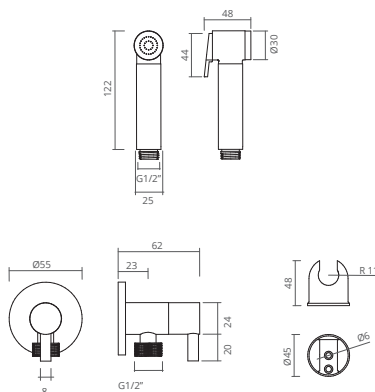

. Brass hygienic shower
 . Holder
 . 120cm shower hose
 . Angle valve pillar tap

*. Douchette hygiénique en laiton
 . Support
 . Flexible de douche 120cm
 . Robinet d'équerre*

. Ducha higiénica en latón
 . Soporte
 . Flexible de ducha 120cm
 . Llave de escuadra

TREVI

BRASS HYGIENIC SHOWER KIT
KIT DOUCHETTE HYGIÉNIQUE EN LAITON
SET DUCHA HIGIÉNICA EN LATÓN

| REF. | |
|------------------|--|
| CT2222216 | WITH ANGLE VALVE PILLAR TAP AVEC ROBINET D'ÉQUERRE CON LLAVE DE ESCUADRA |

CHROMED
CHROME
CROMADO

SUPPLIED IN A CARTON BOX
FOURNI DANS UNE BOÎTE À CARTON
SUMINISTRADO EN UN EMBALAJE DE CARTÓN

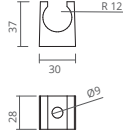
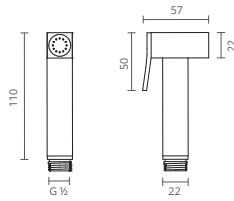

- . Brass hygienic shower
- . Holder
- . 120cm shower hose
- . *Douchette hygiénique en laiton*
- . *Support*
- . *Flexible de douche 120cm*

- . Ducha higiénica en latón
- . Soporte
- . Flexible de ducha 120cm

SQUARE

BRASS HYGIENIC SHOWER KIT
KIT DOUCHETTE HYGIÉNIQUE EN LAITON
SET DUCHA HIGIÉNICA EN LATÓN

REF.

CT2222275

CHROMED
CHROME
CROMADO

SUPPLIED IN A CARTON BOX
FOURNI DANS UNE BOÎTE À CARTON
SUMINISTRADO EN UN EMBALAJE DE CARTÓN

- . Brass hygienic shower
- . Holder
- . 120cm shower hose
- . *Douchette hygiénique en laiton*
- . *Support*
- . *Flexible de douche 120cm*

- . Ducha higiénica en latón
- . Soporte
- . Flexible de ducha 120cm

- . Ducha higiénica en latón
- . Soporte
- . Flexible de ducha 120cm

TREVI

BRASS HYGIENIC SHOWER KIT
KIT DOUCHETTE HYGIÉNIQUE EN LAITON
SET DUCHA HIGIÉNICA EN LATÓN

REF.

CT2222215

CHROMED
CHROME
CROMADO

SUPPLIED IN A CARTON BOX
FOURNI DANS UNE BOÎTE À CARTON
SUMINISTRADO EN UN EMBALAJE DE CARTÓN

- . ABS hygienic shower
- . Holder
- . 120cm shower hose
- . Angle valve pillar tap
- . *Douchette hygiénique en ABS*
- . *Support*
- . *Flexible de douche 120cm*
- . *Robinet d'équerre*

- . Ducha higiénica en ABS
- . Soporte
- . Flexible de ducha 120cm
- . Llave de escuadra

- . Ducha higiénica en ABS
- . Soporte
- . Flexible de ducha 120cm
- . Llave de escuadra

TIVOLI

ABS HYGIENIC SHOWER KIT
KIT DOUCHETTE HYGIÉNIQUE EN ABS
SET DUCHA HIGIÉNICA EN ABS

REF.

CT2222241

WITH ANGLE VALVE PILLAR TAP
AVEC ROBINET D'ÉQUERRE
CON LLAVE DE ESCUADRA

CHROMED
CHROME
CROMADO

SUPPLIED IN A CARTON BOX
FOURNI DANS UNE BOÎTE À CARTON
SUMINISTRADO EN UN EMBALAJE DE CARTÓN

- . ABS hygienic shower
- . Holder
- . 120cm shower hose
- . *Douchette hygiénique en ABS*
- . *Support*
- . *Flexible de douche 120cm*

- . Ducha higiénica en ABS
- . Soporte
- . Flexible de ducha 120cm

- . Ducha higiénica en ABS
- . Soporte
- . Flexible de ducha 120cm

TIVOLI

ABS HYGIENIC SHOWER KIT
KIT DOUCHETTE HYGIÉNIQUE EN ABS
SET DUCHA HIGIÉNICA EN ABS

REF.

CT2222240

CHROMED
CHROME
CROMADO

SUPPLIED IN A CARTON BOX
FOURNI DANS UNE BOÎTE À CARTON
SUMINISTRADO EN UN EMBALAJE DE CARTÓN

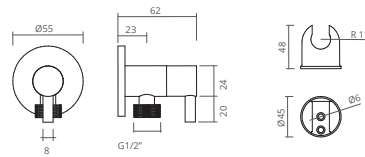
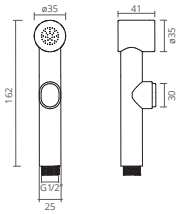

- . ABS hygienic shower
- . Holder
- . 120cm shower hose
- . Angle valve pillar tap
- . *Douchette hygiénique en ABS*
- . *Support*
- . *Flexible de douche 120cm*
- . *Robinet d'équerre*

- . Ducha higiénica en ABS
- . Soporte
- . Flexible de ducha 120cm
- . Llave de escuadra

- . Ducha higiénica en ABS
- . Soporte
- . Flexible de ducha 120cm
- . Llave de escuadra

TIVOLI

ABS HYGIENIC SHOWER KIT
KIT DOUCHETTE HYGIÉNIQUE EN ABS
SET DUCHA HIGIÉNICA EN ABS

REF.

CT2222241

WITH ANGLE VALVE PILLAR TAP
AVEC ROBINET D'ÉQUERRE
CON LLAVE DE ESCUADRA

CHROMED
CHROME
CROMADO

SUPPLIED IN A CARTON BOX
FOURNI DANS UNE BOÎTE À CARTON
SUMINISTRADO EN UN EMBALAJE DE CARTÓN

- . ABS hygienic shower
- . Holder
- . 120cm shower hose
- . *Douchette hygiénique en ABS*
- . *Support*
- . *Flexible de douche 120cm*

- . Ducha higiénica en ABS
- . Soporte
- . Flexible de ducha 120cm

- . Ducha higiénica en ABS
- . Soporte
- . Flexible de ducha 120cm

TIVOLI

ABS HYGIENIC SHOWER KIT
KIT DOUCHETTE HYGIÉNIQUE EN ABS
SET DUCHA HIGIÉNICA EN ABS

REF.

CT2222240

CHROMED
CHROME
CROMADO

SUPPLIED IN A CARTON BOX
FOURNI DANS UNE BOÎTE À CARTON
SUMINISTRADO EN UN EMBALAJE DE CARTÓN

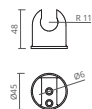
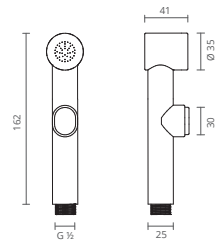

- . ABS hygienic shower
- . Holder
- . 120cm shower hose
- . *Douchette hygiénique en ABS*
- . *Support*
- . *Flexible de douche 120cm*

- . Ducha higiénica en ABS
- . Soporte
- . Flexible de ducha 120cm

- . Ducha higiénica en ABS
- . Soporte
- . Flexible de ducha 120cm

TIVOLI

ABS HYGIENIC SHOWER KIT
KIT DOUCHETTE HYGIÉNIQUE EN ABS
SET DUCHA HIGIÉNICA EN ABS

REF.

CT2222240

CHROMED
CHROME
CROMADO

SUPPLIED IN A CARTON BOX
FOURNI DANS UNE BOÎTE À CARTON
SUMINISTRADO EN UN EMBALAJE DE CARTÓN





towel holders *porte-serviettes* toalleros

A wide range of towel holders just for you. All different models with the same job: to keep towels available and tidy.

Une large gamme de porte-serviettes exclusifs pour vous. Tous les modèles sont différents, mais tous avec la même fonction: garder les serviettes disponibles et rangées.

Una amplia gama de toalleros para ti. Todos son modelos diferentes, pero cumplen la misma función: mantener las toallas disponibles y ordenadas.

LIBERTY

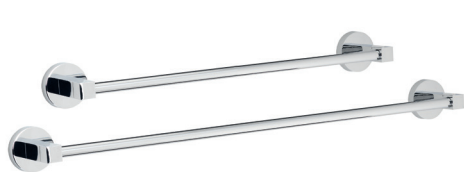

TOWEL HOLDERS
PORTE-SERVIETTES
TOALLEROS
45 cm / 60 cm



TOWEL RING HOLDER
ANNEAU DE PORTE-SERVIETTE
TOALLERO DE ANILLA



TOILET PAPER HOLDER
PORTE-PAPIER
PORTAROLLO



HOOK
PATÈRE
PERCHA



5-PIECE TOWEL HOLDER KIT
KIT PORTE-SERVIETTE - 5 PIÈCES
KIT TOALLERO - 5 PIEZAS

| REF. | |
|--------------|---|
| KIT 1 | CT1202020 TOWEL HOLDERS + TOWEL RING HOLDER + TOILET PAPER HOLDER + HOOK + SOAP DISH PORTE-SERVIETTES + ANNEAU DE PORTE-SERVIETTE + PORTE-PAPIER + PATÈRE + PORTE-SAVON TOALLEROS + TOALLERO DE ANILLA + PORTAROLLO + PERCHA + JABONERA |
| KIT 2 | CT1202021 TOWEL HOLDERS + TOWEL RING HOLDER + TOILET PAPER HOLDER + HOOK + GLASS HOLDER PORTE-SERVIETTES + ANNEAU DE PORTE-SERVIETTE + PORTE-PAPIER + PATÈRE + PORTE-VERRE TOALLEROS + TOALLERO DE ANILLA + PORTAROLLO + PERCHA + PORTAVASO |

CHROMED
CHROME
CROMADO

SUPPLIED IN A CARTON BOX
FOURNI DANS UNE BOÎTE À CARTON
SUMINISTRADO EN UN EMBALAJE DE CARTÓN

MAXI



TOWEL HOLDERS
PORTE-SERVIETTES
TOALLEROS
45 cm / 60 cm



TOWEL RING HOLDER
ANNEAU DE PORTE-SERVIETTE
TOALLERO DE ANILLA



TOILET PAPER HOLDER
PORTE-PAPIER
PORTAROLLO



HOOK
PATÈRE
PERCHA



5-PIECE TOWEL HOLDER KIT
KIT PORTE-SERVIETTE - 5 PIÈCES
KIT TOALLERO - 5 PIEZAS

| REF. | |
|--------------|---|
| KIT 1 | CT1202060 TOWEL HOLDERS + TOWEL RING HOLDER + TOILET PAPER HOLDER + HOOK + SOAP DISH PORTE-SERVIETTES + ANNEAU DE PORTE-SERVIETTE + PORTE-PAPIER + PATÈRE + PORTE-SAVON TOALLEROS + TOALLERO DE ANILLA + PORTAROLLO + PERCHA + JABONERA |
| KIT 2 | CT1202061 TOWEL HOLDERS + TOWEL RING HOLDER + TOILET PAPER HOLDER + HOOK + GLASS HOLDER PORTE-SERVIETTES + ANNEAU DE PORTE-SERVIETTE + PORTE-PAPIER + PATÈRE + PORTE-VERRE TOALLEROS + TOALLERO DE ANILLA + PORTAROLLO + PERCHA + PORTAVASO |

CHROMED
CHROME
CROMADO

SUPPLIED IN A CARTON BOX
FOURNI DANS UNE BOÎTE À CARTON
SUMINISTRADO EN UN EMBALAJE DE CARTÓN

OBI



TOWEL HOLDERS
PORTE-SERVIETTES
TOALLEROS
45 cm / 60 cm



TOWEL RING HOLDER
ANNEAU DE PORTE-SERVIETTE
TOALLERO DE ANILLA



TOILET PAPER HOLDER
PORTE-PAPIER
PORTAROLLO



HOOK
PATÈRE
PERCHA

5-PIECE TOWEL HOLDER KIT
KIT PORTE-SERVIETTE - 5 PIÈCES
KIT TOALLERO - 5 PIEZAS

| REF. | |
|------------------|--|
| CTI202210 | TOWEL HOLDERS + TOWEL RING HOLDER + TOILET PAPER HOLDER + HOOK + SOAP DISH PORTE-SERVIETTES + ANNEAU DE PORTE-SERVIETTE + PORTE-PAPIER + PATÈRE + PORTE-SAVON TOALLEROS + TOALLERO DE ANILLA + PORTAROLLO + PERCHA + JABONERA |
| CTI202211 | TOWEL HOLDERS + TOWEL RING HOLDER + TOILET PAPER HOLDER + HOOK + GLASS HOLDER PORTE-SERVIETTES + ANNEAU DE PORTE-SERVIETTE + PORTE-PAPIER + PATÈRE + PORTE-VERRE TOALLEROS + TOALLERO DE ANILLA + PORTAROLLO + PERCHA + PORTAVASO |

CHROMED
CHROME
CROMADO

SUPPLIED IN A CARTON BOX
FOURNI DANS UNE BOTTE À CARTON
SUMINISTRADO EN UN EMBALAJE DE CARTÓN

KIT 1



W/ SOAP DISH
A/ PORTE-SAVON
C/ JABONERA

KIT 2



W/ GLASS HOLDER
A/ PORTE-VERRE
C/ PORTAVASO

OCEAN



TOWEL HOLDERS
PORTE-SERVIETTES
TOALLEROS
45 cm / 60 cm



TOWEL RING HOLDER
ANNEAU DE PORTE-SERVIETTE
TOALLERO DE ANILLA



TOILET PAPER HOLDER
PORTE-PAPIER
PORTAROLLO



HOOK
PATÈRE
PERCHA

5-PIECE TOWEL HOLDER KIT
KIT PORTE-SERVIETTE - 5 PIÈCES
KIT TOALLERO - 5 PIEZAS

| REF. | |
|------------------|---|
| CTI202250 | 2 TOWEL HOLDERS + TOWEL RING HOLDER + TOILET PAPER HOLDER + HOOK 2 PORTE-SERVIETTES + ANNEAU DE PORTE-SERVIETTE + PORTE-PAPIER + PATÈRE 2 TOALLEROS + TOALLERO DE ANILLA + PORTAROLLO + PERCHA |

CHROMED
CHROME
CROMADO

SUPPLIED IN A CARTON BOX
FOURNI DANS UNE BOTTE À CARTON
SUMINISTRADO EN UN EMBALAJE DE CARTÓN

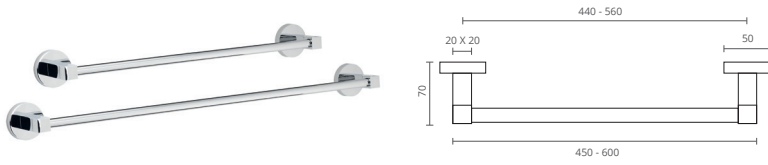

TOWEL HOLDERS
PORTE-SERVIETTES
TOALLEROS

| REF. | MEASURES MESURES MEDIDAS |
|------------------|------------------------------|
| CT1201405 | 45 cm |
| CT1201410 | 60 cm |

CHROMED
 CHROME
 CROMADO



TOWEL RING HOLDER
ANNEAU DE PORTE-SERVIETTE
TOALLERO DE ANILLA

| REF. | MEASURES MESURES MEDIDAS |
|------------------|------------------------------|
| CT1201415 | 160 x 55 x 160 mm |

CHROMED
 CHROME
 CROMADO



TOILET PAPER HOLDER
PORTE-PAPIER
PORTAROLLO

| REF. | MEASURES MESURES MEDIDAS |
|------------------|------------------------------|
| CT1201420 | 130 x 40 x 105 mm |

CHROMED
 CHROME
 CROMADO



SOAP DISH
PORTE-SAVON
JABONERA

| REF. | MEASURES MESURES MEDIDAS |
|------------------|------------------------------|
| CT1201430 | Ø110 mm |

CHROMED
 CHROME
 CROMADO



GLASS HOLDER
PORTE-VERRE
PORTAVASO

| REF. | MEASURES MESURES MEDIDAS |
|------------------|------------------------------|
| CT1201425 | 70 x 110 x 100 mm |

CHROMED
 CHROME
 CROMADO



HOOK
PATÈRE
PERCHA

| REF. | MEASURES MESURES MEDIDAS |
|------------------|------------------------------|
| CT1201450 | 98 x 50 mm |

CHROMED
 CHROME
 CROMADO

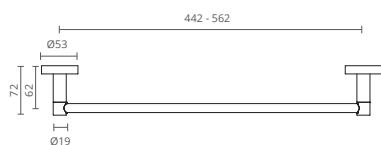

TOWEL HOLDERS
PORTE-SERVIETTES
TOALLEROS

| REF. | MEASURES / MESURES / MEDIDAS |
|------------------|------------------------------|
| CT1201505 | 45 cm |
| CT1201510 | 60 cm |

CHROMED
 CHROME
 CROMADO

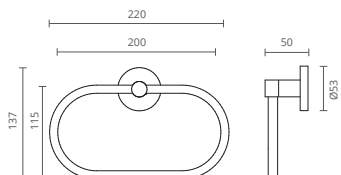

TOWEL RING HOLDER
ANNEAU DE PORTE-SERVIETTE
TOALLERO DE ANILLA

| REF. | MEASURES / MESURES / MEDIDAS |
|------------------|------------------------------|
| CT1201515 | 220 x 50 x 137 mm |

CHROMED
 CHROME
 CROMADO

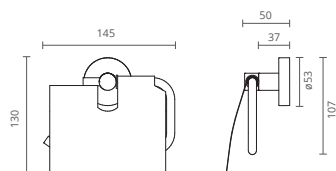

TOILET PAPER HOLDER
PORTE-PAPIER
PORTAROLLO

| REF. | MEASURES / MESURES / MEDIDAS |
|------------------|------------------------------|
| CT1201520 | 145 x 50 x 130 mm |

CHROMED
 CHROME
 CROMADO

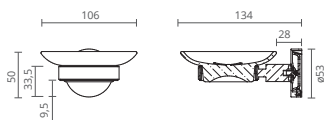

SOAP DISH
PORTE-SAVON
JABONERA

| REF. | MEASURES / MESURES / MEDIDAS |
|------------------|------------------------------|
| CT1201530 | Ø110 mm |

CHROMED
 CHROME
 CROMADO

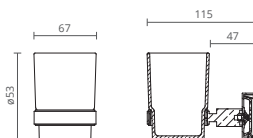

GLASS HOLDER
PORTE-VERRE
PORTAVASO

| REF. | MEASURES / MESURES / MEDIDAS |
|------------------|------------------------------|
| CT1201525 | 67 x 115 x 53 mm |

CHROMED
 CHROME
 CROMADO

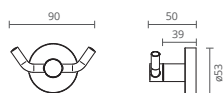

HOOK
PATÈRE
PERCHA

| REF. | MEASURES / MESURES / MEDIDAS |
|------------------|------------------------------|
| CT1201550 | 90 x 50 mm |

CHROMED
 CHROME
 CROMADO



MAXI

ctesi

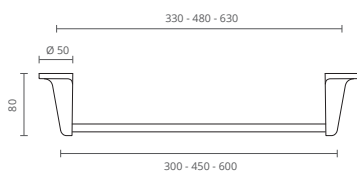

TOWEL HOLDERS
PORTE-SERVIETTES
TOALLEROS

| REF. | MEASURES MESURES MEDIDAS |
|------------------|------------------------------|
| CT1201000 | 30 cm |
| CT1201005 | 45 cm |
| CT1201010 | 60 cm |

CHROMED
CHROME
CROMADO

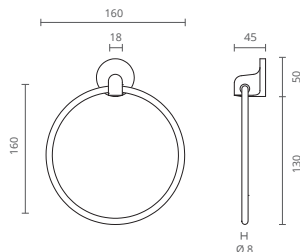

TOWEL RING HOLDER
ANNEAU DE PORTE-SERVIETTE
TOALLERO DE ANILLA

| REF. | MEASURES MESURES MEDIDAS |
|------------------|------------------------------|
| CT1201015 | 160 x 45 x 160 mm |

CHROMED
CHROME
CROMADO

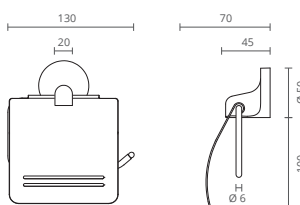

TOILET PAPER HOLDER
PORTE-PAPIER
PORTAROLLO

| REF. | MEASURES MESURES MEDIDAS |
|------------------|------------------------------|
| CT1201020 | 130 x 40 x 105 mm |

CHROMED
CHROME
CROMADO

THIS PRODUCT'S FIXING IS NOT REVERSIBLE
LA FIXATION DE CE PRODUIT N'EST PAS REVERSIBLE
LA FIJACION DEL PRODUCTO NO ES REVERSIBLE

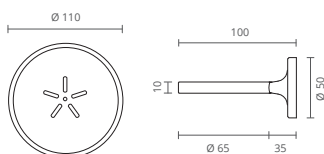

SOAP DISH
PORTE-SAVON
JABONERA

| REF. | MEASURES MESURES MEDIDAS |
|------------------|------------------------------|
| CT1201030 | Ø110 mm |

CHROMED
CHROME
CROMADO

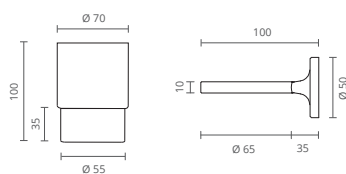

GLASS HOLDER
PORTE-VERRE
PORTAVASO

| REF. | MEASURES MESURES MEDIDAS |
|------------------|------------------------------|
| CT1201025 | 70 x 55 x 100 mm |

CHROMED
CHROME
CROMADO

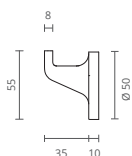

HOOK
PATÈRE
PERCHA

| REF. | MEASURES MESURES MEDIDAS |
|------------------|------------------------------|
| CT1201050 | 45 x 50 mm |

CHROMED
CHROME
CROMADO

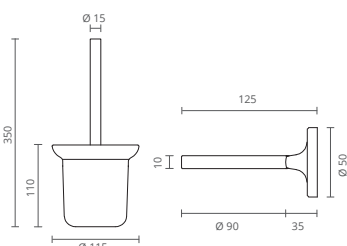

WALL-MOUNTED TOILET BRUSH
PORTE-BALAI MURAL
ESCOBILLERO DE PARED

| REF. | MEASURES MESURES MEDIDAS |
|------------------|------------------------------|
| CT1201060 | 115 x 350 mm |

CHROMED
CHROME
CROMADO

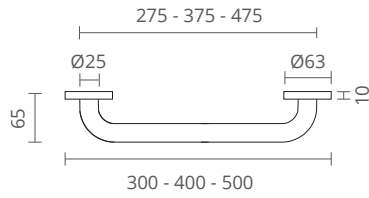

GRAB BAR
BARRE D'APPUI
ASIDERO

| REF. | MEASURES / MESURES / MEDIDAS | |
|------------------|------------------------------|---|
| CT1202500 | 30 cm | STAINLESS STEEL ACIER INOXYDABLE ACERO INOXIDABLE |
| CT1202600 | 40 cm | STAINLESS STEEL ACIER INOXYDABLE ACERO INOXIDABLE |
| CT1202700 | 50 cm | STAINLESS STEEL ACIER INOXYDABLE ACERO INOXIDABLE |

POLISHED
POLI
PULIDO

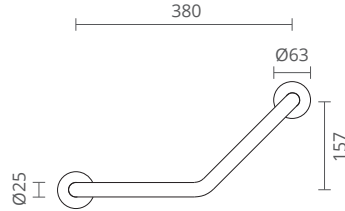

ANGULAR GRAB BAR
BARRE D'APPUI ANGULAIRE
ASIDERO ANGULAR

| REF. | | |
|------------------|--|---|
| CT1202650 | | STAINLESS STEEL ACIER INOXYDABLE ACERO INOXIDABLE |

POLISHED
POLI
PULIDO

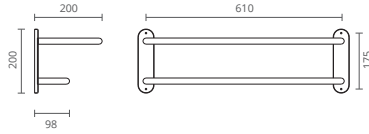

TOWEL HOLDER
PORTE-SERVIETTES
TOALLERO

| REF. | | |
|------------------|---------------------------|---|
| CT1202430 | DOUBLE DOUBLE DOBLE | STAINLESS STEEL ACIER INOXYDABLE ACERO INOXIDABLE |

POLISHED
POLI
PULIDO

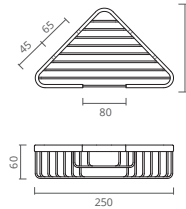
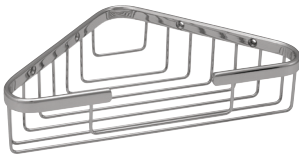

CORNER BATH SPONGE HOLDER
PORTE-ÉPONGE DE COIN
ESPONJERA RINCÓN

| REF. | | |
|------------------|------------------------|---|
| CT1202451 | BIG GRAND GRANDE | STAINLESS STEEL ACIER INOXYDABLE ACERO INOXIDABLE |

POLISHED
POLI
PULIDO

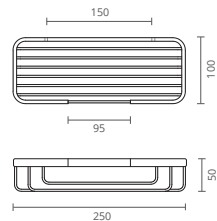

BATH SPONGE HOLDER
PORTE-ÉPONGE
ESPONJERA DE BAÑERA

| REF. | | |
|------------------|------------------------|---|
| CT1202441 | BIG GRAND GRANDE | STAINLESS STEEL ACIER INOXYDABLE ACERO INOXIDABLE |

POLISHED
POLI
PULIDO

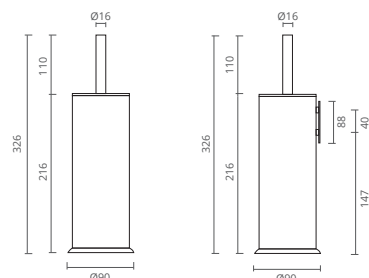

TOILET BRUSH
PORTE-BALAI
ESCOBILLERO

| REF. | | |
|------------------|----------|----------------------|
| CT1202460 | A | FLOOR SOL SUELO |
| CT1202465 | B | WALL MURAL PARED |

POLISHED
POLI
PULIDO





clean&safe clean&safe clean&safe



This range of products has been specially designed for people with reduced mobility. This set of products stands out for its ergonomics, stability and comfort. Durable and comfortable products for a daily use in inclusive bathroom spaces.

Cette gamme de produits a été spécialement conçue pour les personnes à mobilité réduite. Cet ensemble de produits se distingue par son ergonomie, sa stabilité et son confort. Ce sont des produits durables et confortables pour une utilisation quotidienne dans les salles de bains inclusifs.

Esta gama ha sido diseñada especialmente para personas con movilidad reducida. Este conjunto de productos se destaca por su ergonomía, estabilidad y comodidad. Se pretende que este tipo de productos sea duradero, pero al mismo tiempo cómodo para el uso diario en espacios de baño inclusivos.

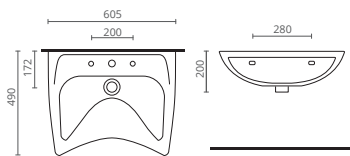

WASHBASIN
 LAVABO
 LAVABO

| REF. | MEASURES MESURES MEDIDAS |
|------------------|------------------------------|
| BL7502200 | 60x 49 cm |

WHITE
 BLANC
 BLANCO

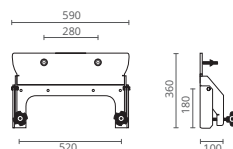

MANUALLY ADJUSTABLE WASHBASIN SUPPORT
 SUPPORT POUR LAVABO AVEC RÉGLAGE MANUEL
 SOPORTE LAVABO DE AJUSTE MANUAL

| REF. | MEASURES MESURES MEDIDAS |
|------------------|------------------------------|
| BL7502291 | WHITE BLANC BLANCO |

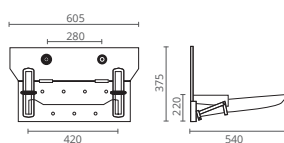

RECLINING WASHBASIN SUPPORT
 SUPPORT INCLINABLE POUR LAVABO
 SOPORTE BASCULANTE PARA LAVABO

| REF. | MEASURES MESURES MEDIDAS |
|------------------|------------------------------|
| BL7502296 | WHITE BLANC BLANCO |

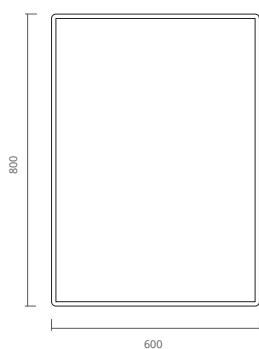

TILT MIRROR
 MIROIR ENCADRÉ INCLINABLE
 ESPEJO BASCULANTE

| REF. | MEASURES MESURES MEDIDAS | MATERIAL |
|------------------|------------------------------|---|
| CT1205155 | 60 x 80 cm | STAINLESS STEEL ACIER INOXYDABLE ACERO INOXIDABLE |

AIISI 304 STAINLESS STEEL
 ACIER INOXYDABLE AISI 304
 ACERO INOXIDABLE AISI 304

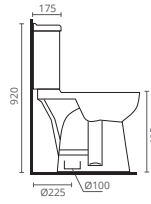
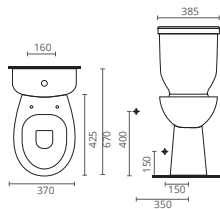

TOILET
CUVETTE
INODORO

REF.

BL7502235

COMPACT W/ DUROPLAST TOILET SEAT COVER
COMPACTE A/ ABATTANT EN DUROPLAST
COMPACTO C/ ASIENTO WC EN DUROPLAST

WHITE
BLANC
BLANCO

VERTICAL OUTLET
SORTIE VERTICALE
SALIDA VERTICAL

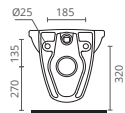
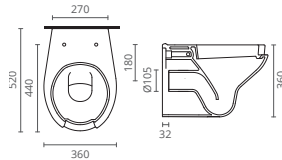

WALL-HUNG TOILET AND TOILET SEAT COVER
TOILETTE SUSPENDUE ET ABATTANT
INODORO SUSPENDIDO ASIENTO INODORO

REF.

BL7502245

WALL-HUNG TOILET
TOILETTE SUSPENDUE
INODORO SUSPENDIDO

BL7502286

WHITE MARINE PLYWOOD TOILET SEAT COVER
ABATTANT BLANC EN CONTRAPLAQUÉ MARITIME
ASIENTO INODORO BLANCO EN CONTRACHAPADO MARINO

WHITE
BLANC
BLANCO

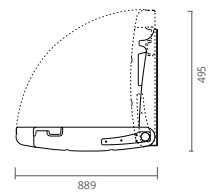
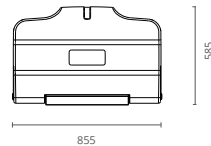

ULTRA RESISTANT MATERIAL
MATÉRIAU ULTRA RÉSISTANT
MATERIAL ULTRA RESISTENTE



ANTIBACTERIAL MATERIAL
MATÉRIEL ANTIBACTÉRIEN
MATERIAL ANTIBACTERIANO



EQUIPPED WITH SAFETY BELT
ÉQUIPÉE D'UNE
CEINTURE DE SÉCURITÉ
EQUIPADO CON
CINTURÓN DE SEGURIDAD



UP TO 11KG OR
12-MONTH-OLD BABIES
POUR BÉBÉS JUSQU'À
11KG OU 12 MOIS
PARA BEBÉS HASTA
11KG O 12 MESES

HORIZONTAL BABY CHANGING TABLE
TABLE À LANGER HORIZONTALE
CAMBIADOR DE BEBÉ HORIZONTAL

REF.

CT1205900

HIGH DENSITY POLYETHYLENE
POLYÉTHYLÈNE DE HAUTE DENSITÉ
POLIETILENO DE ALTA DENSIDAD

ACCORDING TO EN12221 STANDARDS
SELON LA NORME EN12221
DE ACUERDO CON LA NORMATIVA EN12221

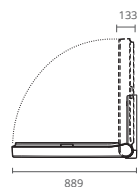

ULTRA RESISTANT MATERIAL
MATÉRIAU ULTRA RÉSISTANT
MATERIAL ULTRA RESISTENTE



ANTIBACTERIAL MATERIAL
MATÉRIEL ANTIBACTÉRIEN
MATERIAL ANTIBACTERIANO



EQUIPPED WITH SAFETY BELT
ÉQUIPÉE D'UNE
CEINTURE DE SÉCURITÉ
EQUIPADO CON
CINTURÓN DE SEGURIDAD



UP TO 11KG OR
12-MONTH-OLD BABIES
POUR BÉBÉS JUSQU'À
11KG OU 12 MOIS
PARA BEBÉS HASTA
11KG O 12 MESES

VERTICAL BABY CHANGING TABLE
TABLE À LANGER VERTICALE
CAMBIADOR DE BEBÉ VERTICAL

REF.

CT1205905

HIGH DENSITY POLYETHYLENE
POLYÉTHYLÈNE DE HAUTE DENSITÉ
POLIETILENO DE ALTA DENSIDAD

ACCORDING TO EN12221 STANDARDS
SELON LA NORME EN12221
DE ACUERDO CON LA NORMATIVA EN12221

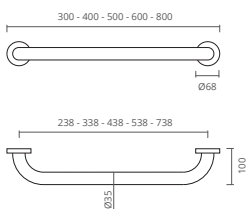

Ø35 mm - Tested and approved by a certified lab, according to the DL 163/2006 standard
 Ø35 mm - *Produit testé et approuvé par un laboratoire certifié, conformément à la norme DL 163/2006*
 Ø35 mm - Producto probado y aprobado por un laboratorio certificado, de acuerdo con la normativa DL 163/2006

GRAB BAR
BARRE D'APPUI
ASIDERO

| REF. | MEASURES MESURES MEDIDAS | |
|------------------|------------------------------|---|
| CTI205000 | 30 cm | STAINLESS STEEL ACIER INOXYDABLE ACERO INOXIDABLE |
| CTI205002 | 40 cm | |
| CTI205004 | 50 cm | |
| CTI205006 | 60 cm | |
| CTI205008 | 80 cm | |

AISI 304 STAINLESS STEEL
ACIER INOXYDABLE AISI 304
ACERO INOXIDABLE AISI 304

Ø35 mm

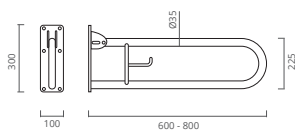

Ø35 mm - Tested and approved by a certified lab, according to the DL 163/2006 standard
 Ø35 mm - *Produit testé et approuvé par un laboratoire certifié, conformément à la norme DL 163/2006*
 Ø35 mm - Producto probado y aprobado por un laboratorio certificado, de acuerdo con la normativa DL 163/2006

FOLDING GRAB BAR W/ PAPER HOLDER
BARRE D'APPUI RABATTABLE A/PORTE-PAPIER
ASIDERO FOLDABLE CON PORTARROLLOS

| REF. | MEASURES MESURES MEDIDAS | |
|------------------|------------------------------|---|
| CTI205050 | 60 cm | STAINLESS STEEL ACIER INOXYDABLE ACERO INOXIDABLE |
| CTI205060 | 80 cm | |

AISI 304 STAINLESS STEEL
ACIER INOXYDABLE AISI 304
ACERO INOXIDABLE AISI 304

Ø35 mm

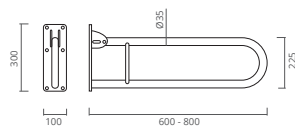

Ø35 mm - Tested and approved by a certified lab, according to the DL 163/2006 standard
 Ø35 mm - *Produit testé et approuvé par un laboratoire certifié, conformément à la norme DL 163/2006*
 Ø35 mm - Producto probado y aprobado por un laboratorio certificado, de acuerdo con la normativa DL 163/2006

FOLDING GRAB BAR
BARRE D'APPUI RABATTABLE
ASIDERO FOLDABLE

| REF. | MEASURES MESURES MEDIDAS | |
|------------------|------------------------------|---|
| CTI205051 | 60 cm | STAINLESS STEEL ACIER INOXYDABLE ACERO INOXIDABLE |
| CTI205061 | 80 cm | |

AISI 304 STAINLESS STEEL
ACIER INOXYDABLE AISI 304
ACERO INOXIDABLE AISI 304

Ø35 mm

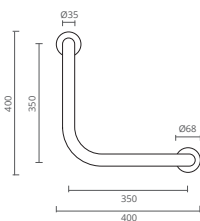

Ø35 mm - Tested and approved by a certified lab, according to the DL 163/2006 standard
 Ø35 mm - *Produit testé et approuvé par un laboratoire certifié, conformément à la norme DL 163/2006*
 Ø35 mm - Producto probado y aprobado por un laboratorio certificado, de acuerdo con la normativa DL 163/2006

90° GRAB BAR
BARRE D'APPUI 90°
ASIDERO 90°

| REF. | MEASURES MESURES MEDIDAS | |
|------------------|------------------------------|---|
| CTI205015 | 35 x 35 cm | STAINLESS STEEL ACIER INOXYDABLE ACERO INOXIDABLE |

AISI 304 STAINLESS STEEL
ACIER INOXYDABLE AISI 304
ACERO INOXIDABLE AISI 304

Ø35 mm

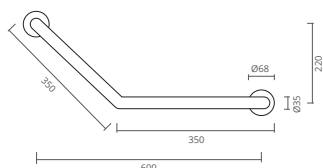

Ø35 mm - Tested and approved by a certified lab, according to the DL 163/2006 standard
 Ø35 mm - *Produit testé et approuvé par un laboratoire certifié, conformément à la norme DL 163/2006*
 Ø35 mm - Producto probado y aprobado por un laboratorio certificado, de acuerdo con la normativa DL 163/2006

135° GRAB BAR
BARRE D'APPUI 135°
ASIDERO 135°

| REF. | MEASURES MESURES MEDIDAS | |
|------------------|------------------------------|---|
| CTI205010 | 35 x 35 cm | STAINLESS STEEL ACIER INOXYDABLE ACERO INOXIDABLE |

AISI 304 STAINLESS STEEL
ACIER INOXYDABLE AISI 304
ACERO INOXIDABLE AISI 304

Ø35 mm

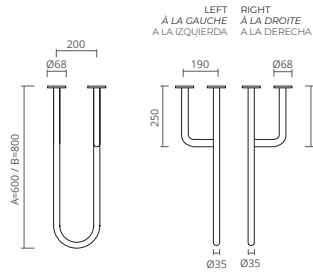

GRAB BAR W/ 3 ANCHORING POINTS
BARRE D'APPUI A/3 FIXATIONS
ASIDERO CON 3 FONDEADEROS

| REF. | MEASURES MESURES / MEDIDAS | | |
|------------------|---------------------------------------|---------------------------------------|---|
| CT1205030 | 60 cm | RIGHT À LA DROITE A LA DERECHA | STAINLESS STEEL ACIER INOXYDABLE ACERO INOXIDABLE |
| CT1205031 | | LEFT À LA GAUCHE A LA IZQUIERDA | |
| CT1205035 | RIGHT À LA DROITE A LA DERECHA | | |
| CT1205036 | LEFT À LA GAUCHE A LA IZQUIERDA | | |

ISI 304 STAINLESS STEEL
 ACIER INOXYDABLE AISI 304
 ACERO INOXIDABLE AISI 304

Ø35 mm

Ø35 mm - Tested and approved by a certified lab, according to the DL 163/2006 standard
 Ø35 mm - Produit testé et approuvé par un laboratoire certifié, conformément à la norme DL 163/2006
 Ø35 mm - Producto probado y aprobado por un laboratorio certificado, de acuerdo con la normativa DL 163/2006

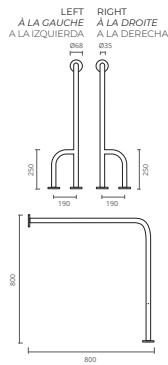

WALL-TO-FLOOR GRAB BAR
BARRE D'APPUI MUR - SOL
ASIDERO DE PARED A PISO

| REF. | MEASURES MESURES / MEDIDAS | | |
|------------------|-------------------------------|---------------------------------------|---|
| CT1205040 | 80 x 80 cm | RIGHT À LA DROITE A LA DERECHA | STAINLESS STEEL ACIER INOXYDABLE ACERO INOXIDABLE |
| CT1205041 | | LEFT À LA GAUCHE A LA IZQUIERDA | |

ISI 304 STAINLESS STEEL
 ACIER INOXYDABLE AISI 304
 ACERO INOXIDABLE AISI 304

Ø35 mm

Ø35 mm - Tested and approved by a certified lab, according to the DL 163/2006 standard
 Ø35 mm - Produit testé et approuvé par un laboratoire certifié, conformément à la norme DL 163/2006
 Ø35 mm - Producto probado y aprobado por un laboratorio certificado, de acuerdo con la normativa DL 163/2006

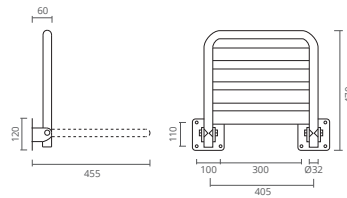

FOLDING SHOWER SEAT
SIÈGE DE DOUCHE RABATTABLE
ASIENTO DE DUCHA PLEGABLE

| REF. | |
|------------------|---|
| CT1205105 | STAINLESS STEEL ACIER INOXYDABLE ACERO INOXIDABLE |

ISI 304 STAINLESS STEEL
 ACIER INOXYDABLE AISI 304
 ACERO INOXIDABLE AISI 304

120 kg

folding
rabattable
plegable

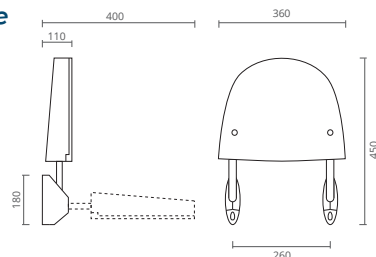

FOLDING SHOWER SEAT
SIÈGE DE DOUCHE RABATTABLE
ASIENTO DE DUCHA PLEGABLE

| REF. | |
|------------------|---|
| CT1202495 | ABS + STAINLESS STEEL SUPPORT ABS + SUPPORT EN ACIER INOXYDABLE ABS + SOPORTE EN ACERO INOXIDABLE |

120 kg

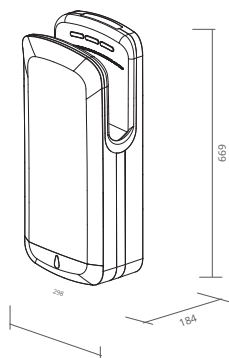

WIND

HAND DRYER
SÈCHE-MAINS
SECADORA DE MANOS

REF.

CT1205871 SILVER | ARGENT | PLATA

CT1205870 WHITE | BLANC | BLANCO

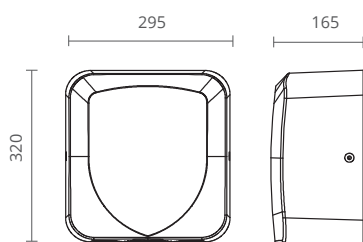

HD1800

HAND DRYER
SÈCHE-MAINS
SECADORA DE MANOS

REF.

CT1205855 STAINLESS STEEL
ACIER INOXYDABLE | ACERO INOXIDABLE

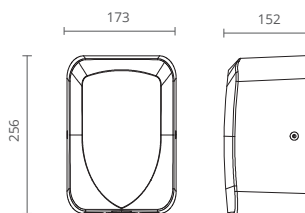

HD1350

HAND DRYER
SÈCHE-MAINS
SECADORA DE MANOS

REF.

CT1205842 STAINLESS STEEL
ACIER INOXYDABLE | ACERO INOXIDABLE

CT1205843 WHITE | BLANC | BLANCO

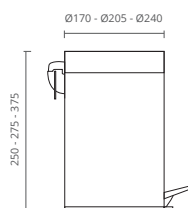

SOFT-CLOSE TOILET BIN
CORBEILLE À PAPIER A/ SYSTÈME SOFT-CLOSE
PAPELERA DE BAÑO CON SISTEMA DE CIERRE SUAVE

REF.

CT1205500 STAINLESS STEEL 3L

CT1205502 ACIER INOXYDABLE 5L

CT1205504 ACERO INOXIDABLE 12L

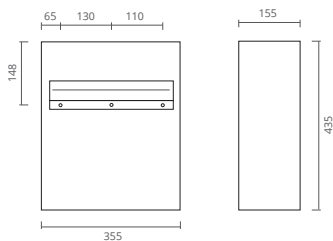

WALL-MOUNTED TOILET BIN
CORBEILLE MURAL À PAPIER
PAPELERA DE BAÑO DE PARED

REF.

CT1205550 STAINLESS STEEL 25 L
ACIER INOXYDABLE
ACERO INOXIDABLE



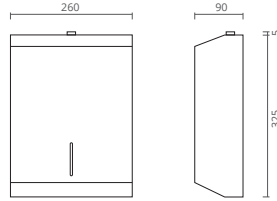

DT400

PAPER DISPENSER
DISTRIBUTEUR DE PAPIER
 DISTRIBUIDOR DE PAPEL

REF.

CT1205400 STAINLESS STEEL
 ACIER INOXYDABLE | ACERO INOXIDABLE

ASI 304 STAINLESS STEEL
 ACIER INOXYDABLE AISI 304
 ACERO INOXIDABLE AISI 304

BRUSHED STAINLESS STEEL
 ACIER INOXYDABLE BROUSSE
 ACERO INOXIDABLE CEPILLADO

400 TISSUES
 400 FEUILLES
 400 HOJAS

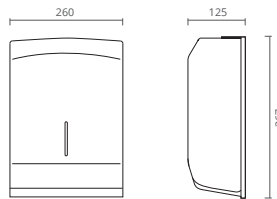

DTN600

PAPER DISPENSER
DISTRIBUTEUR DE PAPIER
 DISTRIBUIDOR DE PAPEL

REF.

CT1205440 ABS | ABS | ABS

WHITE
 BLANC
 BLANCO

600 TISSUES
 600 FEUILLES
 600 HOJAS

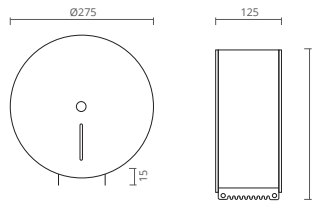

DJI JUMBO

PAPER DISPENSER
DISTRIBUTEUR DE PAPIER
 DISTRIBUIDOR DE PAPEL

REF.

CT1205300 STAINLESS STEEL
 ACIER INOXYDABLE | ACERO INOXIDABLE

ASI 304 STAINLESS STEEL
 ACIER INOXYDABLE AISI 304
 ACERO INOXIDABLE AISI 304

BRUSHED STAINLESS STEEL
 ACIER INOXYDABLE BROUSSE
 ACERO INOXIDABLE CEPILLADO

Ø220 mm

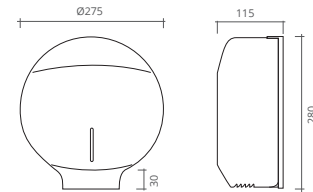

DJN JUMBO

PAPER DISPENSER
DISTRIBUTEUR DE PAPIER
 DISTRIBUIDOR DE PAPEL

REF.

CT1205340 ABS | ABS | ABS

WHITE
 BLANC
 BLANCO

Ø220 mm

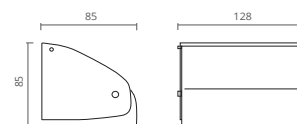

TOILET PAPER HOLDER
PORTE-PAPIER
 PORTARROLLOS

REF.

CT1205620 STAINLESS STEEL
 ACIER INOXYDABLE | ACERO INOXIDABLE

POLISHED STAINLESS STEEL
 ACIER INOXYDABLE POLI
 ACERO INOXIDABLE PULIDO

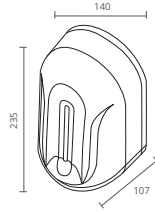

- . Digital circuit with infrared sensor
- . Battery powered
- . Automatically dispenses soap / gel
- . 1100 ml deposit capacity
- . 1 ml drop volume

- . *Circuit numérique avec capteur infrarouge*
- . *Alimenté par des piles*
- . *Distribue automatiquement du savon / gel liquide*
- . *Capacité du réservoir de 1100 ml*
- . *Volume de la goutte: 1 ml*

- . Circuito digital con sensor de infrarojos
- . Operado por pilas
- . Dispensa automáticamente jabón / gel líquido o en spray
- . 1100 ml de capacidad del depósito
- . 1 ml de volumen de goteo

AUTOMATIC DISPENSER
DISTRIBUTEUR AUTOMATIQUE
DISPENSADOR AUTOMÁTICO

| REF. | |
|------------------|--|
| CT1205250 | SOAP/GEL SAVON/GEL JABÓN/GEL |
| CT1205251 | DISINFECTANT SPRAY SPRAY DÉSINFECTANT SPRAY DESINFECTANTE |

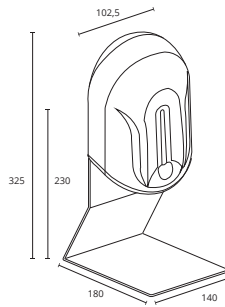
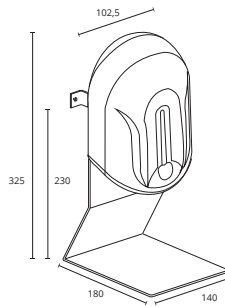

TABLE DISPENSER WITH METAL SUPPORT
DISTRIBUTEUR AUTOMATIQUE POUR TABLES
SOPORTE DE MESA CON DISPENSADOR

| REF. | |
|------------------|--|
| CT1205263 | SOAP/GEL SAVON/GEL JABÓN/GEL |
| CT1205267 | DISINFECTANT SPRAY SPRAY DÉSINFECTANT SPRAY DESINFECTANTE |



WALL-MOUNTED DISPENSER
DISTRIBUTEUR AUTOMATIQUE MURAL
SOPORTE DE PARED CON DISPENSADOR

| REF. | |
|------------------|--|
| CT1205262 | SOAP/GEL SAVON/GEL JABÓN/GEL |
| CT1205266 | DISINFECTANT SPRAY SPRAY DÉSINFECTANT SPRAY DESINFECTANTE |

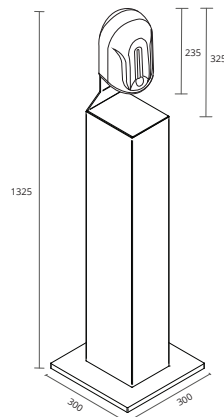

SUPPORT COLUMN DISPENSER
DISTRIBUTEUR AUTOMATIQUE AVEC COLONNE
SOPORTE DE SUELO CON DISPENSADOR

| REF. | |
|------------------|--|
| CT1205261 | SOAP/GEL SAVON/GEL JABÓN/GEL |
| CT1205265 | DISINFECTANT SPRAY SPRAY DÉSINFECTANT SPRAY DESINFECTANTE |





ANTI-CORROSION INNER PLASTIC CANISTER
RÉSERVOIR INTÉRIEUR EN PLASTIQUE (ANTI-CORROSION)
TANQUE INTERIOR DE PLÁSTICO (ANTICORROSIÓN)

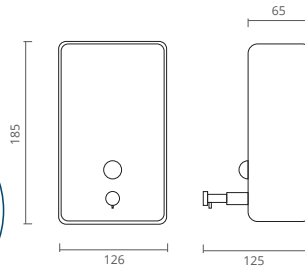

- . Available in vertical format
- . Higher deposit capacity: 1,1 liters
- . Anti-corrosion inner plastic canister

- . Disponible en format verticale
- . Capacité supérieure du réservoir: 1,1 litres
- . Réservoir intérieur en plastique (anti-corrosion)

- . Disponible en formato vertical
- . Tanque con mayor capacidad: 1,1 litros
- . Tanque interior de plástico (anticorrosión)

DSV 12
VERTICAL WALL-MOUNTED SOAP DISPENSER
DISTRIBUTEUR SAVON VERTICAL
DISPENSADOR VERTICAL DE JABÓN

| REF. | |
|------------------|--|
| CT1205200 | STAINLESS STEEL ACIER INOXYDABLE ACERO INOXIDABLE |



- . Available in vertical format
- . Higher deposit capacity: 1,1 liters
- . Anti-corrosion inner plastic canister

- . Disponible en format verticale
- . Capacité supérieure du réservoir: 1,1 litres
- . Réservoir intérieur en plastique (anti-corrosion)

- . Disponible en formato vertical
- . Tanque con mayor capacidad: 1,1 litros
- . Tanque interior de plástico (anticorrosión)

DSH 12
HORIZONTAL WALL-MOUNTED SOAP DISPENSER
DISTRIBUTEUR SAVON HORIZONTAL
DISPENSADOR HORIZONTAL DE JABÓN

| REF. | |
|------------------|--|
| CT1205210 | STAINLESS STEEL ACIER INOXYDABLE ACERO INOXIDABLE |



- . Manual dispenser
- . Deposit capacity: 1,1 liters
- . 1 ml drop volume

- . Distributeur manuel
- . Capacité du réservoir: 1,1 litres
- . Volume de la goutte: 1 ml

- . Dispensador manual
- . Capacidad del depósito: 1,1 litros
- . 1 ml de volumen de goteo

MANUAL DISPENSER
DISTRIBUTEUR MANUEL
DISPENSADOR MANUAL

| REF. | |
|------------------|----------------------------------|
| CT1205241 | SOAP/GEL SAVON/GEL JABÓN/GEL |



- . Manual dispenser
- . Deposit capacity: 360 ml
- . 1 ml drop volume

- . Distributeur manuel
- . Capacité du réservoir: 360 ml
- . Volume de la goutte: 1 ml

- . Dispensador manual
- . Capacidad del depósito: 360 ml
- . 1 ml de volumen de goteo

MANUAL DISPENSER
DISTRIBUTEUR MANUEL
DISPENSADOR MANUAL

| REF. | |
|------------------|----------------------------------|
| CT1205240 | SOAP/GEL SAVON/GEL JABÓN/GEL |



- . Elbow dispenser
- . Deposit capacity: 1000 ml
- . 1 ml drop volume

- . Distributeur à coude
- . Capacité du réservoir: 1000 ml
- . Volume de la goutte: 1 ml

- . Dispensador de codo
- . Capacidad del depósito: 1000 ml
- . 1 ml de volumen de goteo

ELBOW DISPENSER
DISTRIBUTEUR À COUDE
DISPENSADOR DE CODO

| REF. | |
|------------------|----------------------------------|
| CT1205281 | SOAP/GEL SAVON/GEL JABÓN/GEL |



ANTI-CORROSION INNER PLASTIC CANISTER
RÉSERVOIR INTÉRIEUR EN PLASTIQUE (ANTI-CORROSION)
TANQUE INTERIOR DE PLÁSTICO (ANTICORROSIÓN)

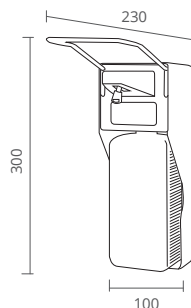
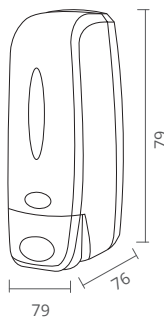
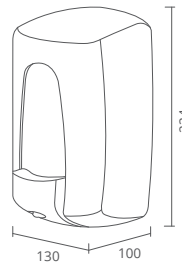
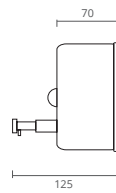
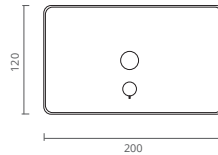

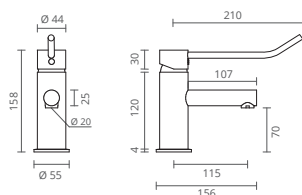

DOC

BASIN SINGLE LEVER MIXER
 MITIGEUR LAVABO
 MEZCLADOR LAVABO

REF.

CT2006700

CHROMED
 CHROME
 CROMADO

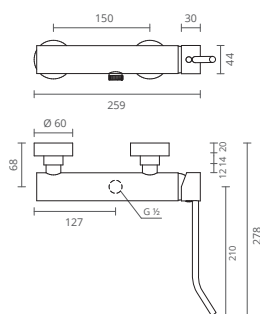

DOC

SHOWER SINGLE LEVER MIXER
 MITIGEUR DE DOUCHE
 MEZCLADOR DE DUCHA

REF.

CT2006730

ABS KIT + SHOWER HOSE
 KIT EN ABS + FLEXIBLE DE DOUCHE
 SET EN ABS + FLEXIBLE DE DUCHA

CHROMED
 CHROME
 CROMADO

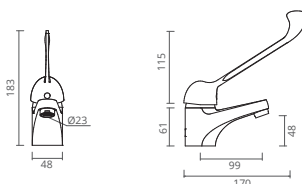

SAFE

BASIN SINGLE LEVER MIXER
 MITIGEUR LAVABO
 MEZCLADOR LAVABO

REF.

CT2006800

CHROMED
 CHROME
 CROMADO

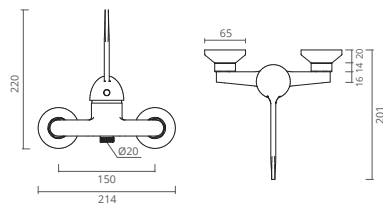

SAFE

SHOWER SINGLE LEVER MIXER
 MITIGEUR DE DOUCHE
 MEZCLADOR DE DUCHA

REF.

CT2006830

ABS KIT + SHOWER HOSE
 KIT EN ABS + FLEXIBLE DE DOUCHE
 SET EN ABS + FLEXIBLE DE DUCHA

CHROMED
 CHROME
 CROMADO

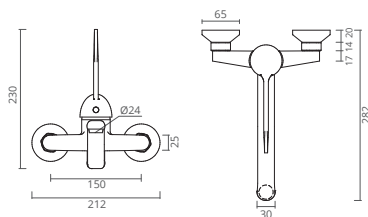

SAFE

WALL-MOUNTED SINK SINGLE LEVER MIXER
 MITIGEUR D'ÉVIER MURAL
 MEZCLADOR MURAL DE FREGADERO

REF.

CT2006950 LOW SPOUT
 BEC INFÉRIEURE | CAÑO INFERIOR

CHROMED
 CHROME
 CROMADO

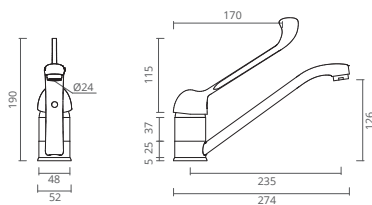

SAFE

SINK SINGLE LEVER MIXER
 MITIGEUR D'ÉVIER
 MEZCLADOR DE FREGADERO

REF.

CT2006940 LOW SPOUT | BEC BAS | CAÑO BAJO

CHROMED
 CHROME
 CROMADO

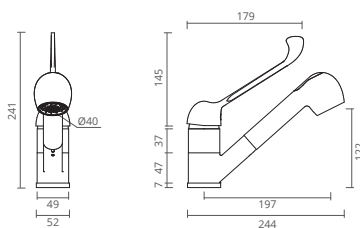

SAFE

SINK SINGLE LEVER MIXER
 MITIGEUR D'ÉVIER
 MEZCLADOR DE FREGADERO

REF.

CT2006942 LOW SPOUT WITH SHOWER
 BEC BAS AVEC DOUCHETTE
 CAÑO BAJO CON DUCHA

CHROMED
 CHROME
 CROMADO

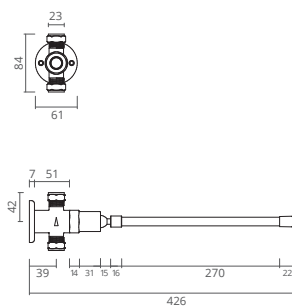

SHOWER TAP
 ROBINET DE DOUCHE
 GRIFO DE DUCHA

REF.

CT5050350 SELF-CLOSING TAP
 TEMPORISÉ | TEMPORIZADO

CHROMED
 CHROME
 CROMADO





ELECTRONIC TAPS ROBINETS ÉLECTRONIQUES GRIFERÍA ELECTRÓNICA

AQUABLOCK is a sensor-blocking system that is activated in case of abusive tap use. We usually find these taps in public spaces to save water and specially for people with reduced mobility. Ctesi® electronic taps can be connected to 220/12V devices or even operated by batteries.

AQUABLOCK est un système qui permet de bloquer le capteur en cas d'utilisation abusive du robinet. Nous trouvons généralement ces robinets dans les espaces publics, comme moyen d'économiser l'eau, mais aussi comme moyen de faciliter leur utilisation pour les personnes à mobilité réduite. Les robinets électroniques Ctesi® peuvent être connectés à des blocs d'alimentation 220/12v ou à des piles.

AQUABLOCK es un sistema que permite bloquear el sensor en caso de que haya un uso abusivo del grifo. Habitualmente encontramos estos grifos en espacios públicos para ahorrar agua y también como forma de facilitar su uso para personas con movilidad reducida. Los grifos electrónicos Ctesi® se pueden conectar con dispositivos de 220/12V o pueden ser operados por pilas.

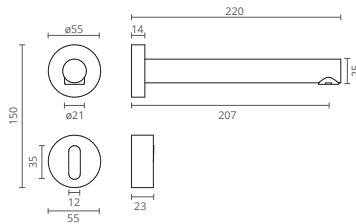

WATER SAVING | ECONOMIE D'EAU | AHORRO DE AGUA
Activation via infra-red sensor, with adjustable automatic closing time. *Activation par capteur infra-rouge, avec possibilité de réglage du temps automatique de fermeture.*
Activación a través del sensor infrarrojo, con posibilidad de ajustar el tiempo de cierre automático.

CLEANING AND HYGIENE | NETTOYAGE ET HYGIÈNE | LIMPIEZA E HIGIENE
Activated by putting hand in the sensor zone. *Le robinet est activé avec détection de la main dans la zone du capteur.*
Activación con la mano en la zona del sensor.

EASY MAINTENANCE | ENTRETIEN FACILE | MANTENIMIENTO FÁCIL
Includes filter to avoid impurities that can affect the tap's proper flow. *Comprend un filtre pour éviter les impuretés qui peuvent affecter le bon débit du robinet.*
Incluye filtro para evitar impurezas que pueden afectar el flujo adecuado del grifo.

MULTIFUNCTIONAL | MULTIFONCTIONNEL | MULTIFUNCIONAL
Operated by 220v devices or by batteries. *Option de connecter le robinet à des blocs d'alimentation 220V ou à des piles.*
Opción de conecta el grifo a dispositivos de 220V o a pilas.

INSIDE

**BUILT-IN WASHBASIN ELECTRONIC TAP
ROBINET ÉLECTRONIQUE DE LAVABO À ENCASTRER
GRIFO ELECTRÓNICO EMPOTRABLE DE LAVABO**

| REF. | |
|-----------|------------------------------|
| CT2300061 | 1 WATER 1 VOIE 1 AGUA |
| CT2300060 | 2 WATERS 2 VOIES 2 AGUAS |

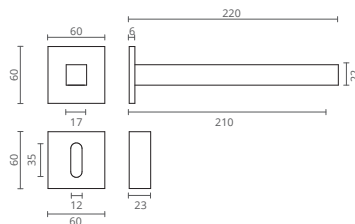

WATER SAVING | ECONOMIE D'EAU | AHORRO DE AGUA
Activation via infra-red sensor, with adjustable automatic closing time. *Activation par capteur infra-rouge, avec possibilité de réglage du temps automatique de fermeture.*
Activación a través del sensor infrarrojo, con posibilidad de ajustar el tiempo de cierre automático.

CLEANING AND HYGIENE | NETTOYAGE ET HYGIÈNE | LIMPIEZA E HIGIENE
Activated by putting hand in the sensor zone. *Le robinet est activé avec détection de la main dans la zone du capteur.*
Activación con la mano en la zona del sensor.

EASY MAINTENANCE | ENTRETIEN FACILE | MANTENIMIENTO FÁCIL
Includes filter to avoid impurities that can affect the tap's proper flow. *Comprend un filtre pour éviter les impuretés qui peuvent affecter le bon débit du robinet.*
Incluye filtro para evitar impurezas que pueden afectar el flujo adecuado del grifo.

MULTIFUNCTIONAL | MULTIFONCTIONNEL | MULTIFUNCIONAL
Operated by 220v devices or by batteries. *Option de connecter le robinet à des blocs d'alimentation 220V ou à des piles.*
Opción de conecta el grifo a dispositivos de 220V o a pilas.

INSIDE SQUARE

**BUILT-IN WASHBASIN ELECTRONIC TAP
ROBINET ÉLECTRONIQUE DE LAVABO À ENCASTRER
GRIFO ELECTRÓNICO EMPOTRABLE DE LAVABO**

| REF. | |
|-----------|------------------------------|
| CT2300051 | 1 WATER 1 VOIE 1 AGUA |
| CT2300050 | 2 WATERS 2 VOIES 2 AGUAS |



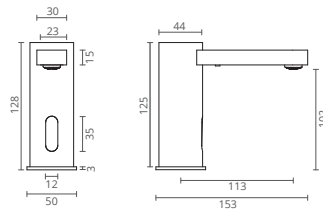

WATER SAVING | ECONOMIE D'EAU | AHORRO DE AGUA
 Activation via infra-red sensor, with adjustable automatic closing time.
Activation par capteur infra-rouge, avec possibilité de réglage du temps automatique de fermeture.
 Activación a través del sensor infrarrojo, con posibilidad de ajustar el tiempo de cierre automático.

CLEANING AND HYGIENE | NETTOYAGE ET HYGIÈNE | LIMPIEZA E HIGIENE
 Activated by putting hand in the sensor zone.
Le robinet est activé avec détection de la main dans la zone du capteur.
 Activación con la mano en la zona del sensor.

EASY MAINTENANCE | ENTRETIEN FACILE | MANTENIMIENTO FÁCIL
 Includes filter to avoid impurities that can affect the tap's proper flow.
Comprend un filtre pour éviter les impuretés qui peuvent affecter le bon débit du robinet.
 Incluye filtro para evitar impurezas que pueden afectar el flujo adecuado del grifo.

MULTIFUNCTIONAL | MULTIFONCTIONNEL | MULTIFUNCIONAL
 Operated by 220v devices or by batteries
Option de connecter le robinet à des blocs d'alimentation 220V ou à des piles.
 Opción de conecta el grifo a dispositivos de 220V o a pilas.

KEEN

WASHBASIN ELECTRONIC TAP
ROBINET ÉLECTRONIQUE DE LAVABO
GRIFO ELECTRÓNICO DE LAVABO

| REF. | |
|------------------|------------------------------|
| CT2300070 | 1 WATER 1 VOIE 1 AGUA |
| CT2300071 | 2 WATERS 2 VOIES 2 AGUAS |



WATER SAVING | ECONOMIE D'EAU | AHORRO DE AGUA
 Activation via infra-red sensor, with adjustable automatic closing time.
Activation par capteur infra-rouge, avec possibilité de réglage du temps automatique de fermeture.
 Activación a través del sensor infrarrojo, con posibilidad de ajustar el tiempo de cierre automático.

CLEANING AND HYGIENE | NETTOYAGE ET HYGIÈNE | LIMPIEZA E HIGIENE
 Activated by putting hand in the sensor zone.
Le robinet est activé avec détection de la main dans la zone du capteur.
 Activación con la mano en la zona del sensor.

EASY MAINTENANCE | ENTRETIEN FACILE | MANTENIMIENTO FÁCIL
 Includes filter to avoid impurities that can affect the tap's proper flow.
Comprend un filtre pour éviter les impuretés qui peuvent affecter le bon débit du robinet.
 Incluye filtro para evitar impurezas que pueden afectar el flujo adecuado del grifo.

MULTIFUNCTIONAL | MULTIFONCTIONNEL | MULTIFUNCIONAL
 Operated by 220v devices or by batteries
Option de connecter le robinet à des blocs d'alimentation 220V ou à des piles.
 Opción de conecta el grifo a dispositivos de 220V o a pilas.

SELF

WASHBASIN ELECTRONIC TAP
ROBINET ÉLECTRONIQUE DE LAVABO
GRIFO ELECTRÓNICO DE LAVABO

| REF. | |
|------------------|------------------------------|
| CT2300075 | 1 WATER 1 VOIE 1 AGUA |
| CT2300076 | 2 WATERS 2 VOIES 2 AGUAS |



WATER SAVING | ECONOMIE D'EAU | AHORRO DE AGUA
 Activation via infra-red sensor, with adjustable automatic closing time.
Activation par capteur infra-rouge, avec possibilité de réglage du temps automatique de fermeture.
 Activación a través del sensor infrarrojo, con posibilidad de ajustar el tiempo de cierre automático.

CLEANING AND HYGIENE | NETTOYAGE ET HYGIÈNE | LIMPIEZA E HIGIENE
 Activated by putting hand in the sensor zone.
Le robinet est activé avec détection de la main dans la zone du capteur.
 Activación con la mano en la zona del sensor.

EASY MAINTENANCE | ENTRETIEN FACILE | MANTENIMIENTO FÁCIL
 Includes filter to avoid impurities that can affect the tap's proper flow.
Comprend un filtre pour éviter les impuretés qui peuvent affecter le bon débit du robinet.
 Incluye filtro para evitar impurezas que pueden afectar el flujo adecuado del grifo.

MULTIFUNCTIONAL | MULTIFONCTIONNEL | MULTIFUNCIONAL
 Operated by 220v devices or by batteries
Option de connecter le robinet à des blocs d'alimentation 220V ou à des piles.
 Opción de conecta el grifo a dispositivos de 220V o a pilas.

PIXEL

WASHBASIN ELECTRONIC TAP
ROBINET ÉLECTRONIQUE DE LAVABO
GRIFO ELECTRÓNICO DE LAVABO

| REF. | |
|------------------|------------------------------|
| CT2300300 | 1 WATER 1 VOIE 1 AGUA |
| CT2300305 | 2 WATERS 2 VOIES 2 AGUAS |

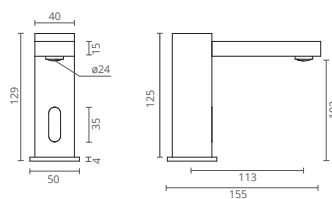
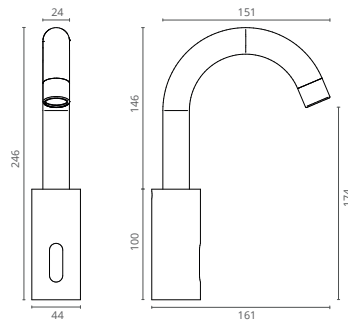



SELF-CLOSING TAPS ROBINETS TEMPORISÉS GRIFERÍA TEMPORIZADA

Ctesi® GREEN is our contribution to a more sustainable planet. Ctesi® has a deep concern for water, one of life's essential resources on the planet. Effortlessly choose taps with economizer cartridges or electronic taps for an efficient use of water in your home or in public spaces, without giving up your comfort.

Ctesi® GREEN est notre contribution à une planète plus durable. Ctesi® est profondément préoccupé par l'avenir et par l'eau, l'une des ressources essentielles pour la vie sur la planète. Choisissez des robinets à cartouches économiseurs ou des robinets électroniques pour une utilisation efficace de l'eau dans votre maison ou dans les espaces publics, sans renoncer à votre confort et sans effort.

Ctesi® GREEN es nuestra contribución para un planeta más sostenible. Ctesi® tiene una profunda preocupación por el agua, el recurso vital para la vida en el planeta. Opta por grifos con cartuchos economizadores o grifos temporizados, sin esfuerzo y con toda la comodidad, para un uso racional del agua en tu hogar o en espacios públicos.

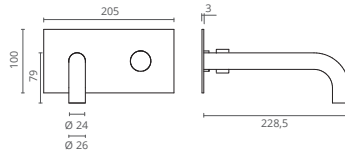

INLUX

BUILT-IN WASHBASIN SELF-CLOSING TAP
 ROBINET TEMPORISÉ DE LAVABO À ENCASTRER
 GRIFO TEMPORIZADO EMPOTRABLE DE LAVABO

| | |
|------------------|--|
| REF. | |
| CT5050008 | |

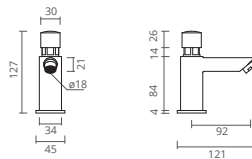

LINE

WASHBASIN SELF-CLOSING TAP
 ROBINET TEMPORISÉ DE LAVABO
 GRIFO TEMPORIZADO DE LAVABO

| | |
|------------------|--|
| REF. | |
| CT5050000 | |

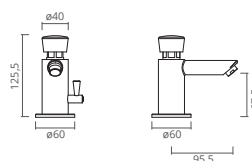

LINE

BASIN SELF-CLOSING MIXER
 MÉLANGEUR TEMPORISÉ DE LAVABO
 MEZCLADOR TEMPORIZADO DE LAVABO

| | |
|------------------|--|
| REF. | |
| CT5050005 | |



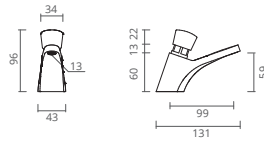

PLUS WASHBASIN TAP
ROBINET DE LAVABO PLUS
 GRIFO DE LAVABO PLUS

REF.

CT5050002

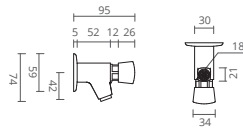

WALL-MOUNTED TAP
ROBINET MURAL
 GRIFO MURAL

REF.

CT5050010 1/2" TAP | *ROBINET 1/2"* | GRIFO 1/2"

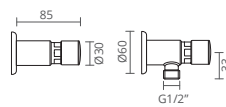

WALL-MOUNTED URINOL SHORT TAP
ROBINET COURT MURAL D'URINOL
 GRIFO CORTO MURAL DE URINOL

REF.

CT5050080 SIMPLE | *SIMPLE* | SIMPLE

CT5050081 WITH CONNECTION
AVEC LIAISON | CON CONEXIÓN

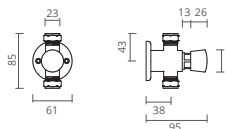

WALL-MOUNTED SHOWER TAP
ROBINET DOUCHE MURALE
 GRIFO DE DUCHA DE PARED

REF.

CT5050050 1 WATER | *1 VOIE* | 1 AGUA



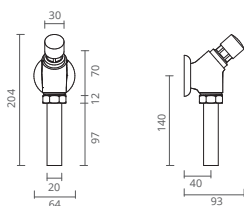

EXTERNAL FLUSH VALVE
DÉBITMÈTRE EXTÉRIEUR
 FLUJÓMETRO EXTERIOR

REF.

CT5050070

CHROMED
 CHROME
 CROMADO

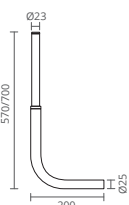

FLUSH VALVE TUBE
TUBE POUR FLUXMÈTRE
 TUBE POUR FLUXMÈTRE

REF.

CT5050250

ADJUSTABLE
RÉGLABLE | AJUSTABLE

CHROMED
 CHROME
 CROMADO

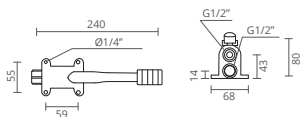

FOOT OPERATED SINGLE LEVER TAP
ROBINET COMMANDE AU PIED
 GRIFO DE PEDAL

REF.

CT5050700 1 WATER | 1 VOIE | 1 AGUA

CHROMED
 CHROME
 CROMADO

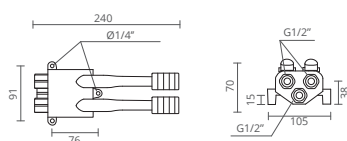

FOOT OPERATED DOUBLE TAP
ROBINET COMMANDE AU PIED DOUBLE
 GRIFO DUPLO DE PEDAL

REF.

CT5050720 2 WATERS | 2 VOIES | 2 AGUAS

CHROMED
 CHROME
 CROMADO

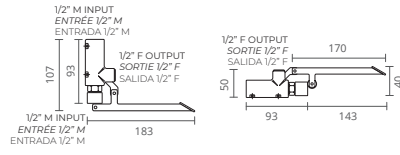

FOOT OPERATED TAP
ROBINET COMMANDE AU PIED
GRIFO DE PEDAL

REF.

CT5050110 1 WATER | 1 VOIE | 1 AGUA

CHROMED
CHROME
CROMADO

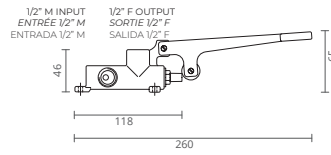

FOOT OPERATED SINGLE LEVER MIXER
MITIGEUR COMMANDE AU PIED
GRIFO MEZCLADOR DE PEDAL

REF.

CT5050115 2 WATERS | 2 VOIES | 2 AGUAS

CHROMED
CHROME
CROMADO

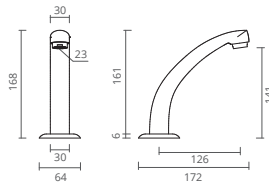

SPOUT
BEC
CAÑO

REF.

CT5050190 CAST | FONT | FUNDIDO

CHROMED
CHROME
CROMADO

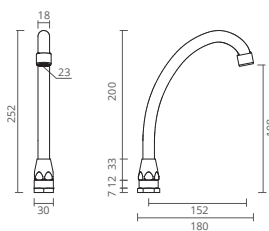

SPOUT
BEC
CAÑO

REF.

CT5050180 TUBE | TUBE | TUBO

CHROMED
CHROME
CROMADO





shower enclosures *cabines de douche* mamparas de ducha

Shower enclosures are an excellent option for your bathroom. All our sets are adaptable to your bathroom space. Choose the best shower enclosure for you, whether it has glass or acrylic panels, and match it with one of our shower columns.

Les cabines de douche sont une excellente option pour votre salle de bains. Tous nos cabines sont adaptables à votre espace. Choisissez la cabine de douche qui convient le mieux, avec des panneaux en verre ou acryliques, et complétez-la avec l'une de nos colonnes de douche.

Las mamparas de ducha son una excelente opción para tu baño. Tenemos diferentes configuraciones, todas adaptables a tu espacio de baño. Elige la mejor mampara de ducha para tu baño, con paneles de vidrio o acrílicos, y complétala con una de nuestras columnas de ducha.

6 mm GLASS
TEMPERED GLASS
NO LOWER PROFILE
CHROMED UPPER WHEELS
REVERSIBLE
190 cm HEIGHT

VERRE 6 mm
VERRE TREMPÉ
SANS PROFIL INFÉRIEUR
ROULETTES SUPÉRIEURES CHROMÉES
RÉVERSIBLE
HAUTEUR 190 cm

VIDRIO 6 mm
VIDRIO TEMPLADO
SIN PERFIL INFERIOR
ROLAMIENTOS SUPERIORES CROMADOS
REVERSIBLE
ALTURA 190 cm

SHOWER ENCLOSURE
CABINE DE DOUCHE
MAMPARA DE DUCHA

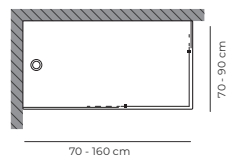

| MEASURES MESURES MEDIDAS | ADJUSTMENT AJUSTEMENT AJUSTAMIENTO | REF. | REF. |
|--------------------------------|--|-----------|------------------------|
| 70 x 70 cm | 68,5 70 - 68,5 70 cm | DB0560000 | DB0560001 |
| 70 x 90 cm | 68,5 70 - 88,5 90 cm | DB0560010 | DB0560011 DB0560012 |
| 70 x 100 cm | 68,5 70 - 98,5 100 cm | DB0560020 | DB0560021 DB0560022 |
| 70 x 110 cm | 68,5 70 - 108,5 110 cm | DB0560030 | DB0560031 DB0560032 |
| 70 x 120 cm | 68,5 70 - 118,5 120 cm | DB0560040 | DB0560041 DB0560042 |
| 70 x 130 cm | 68,5 70 - 128,5 130 cm | DB0560050 | DB0560051 DB0560052 |
| 70 x 140 cm | 68,5 70 - 138,5 140 cm | DB0560060 | DB0560061 DB0560062 |
| 70 x 150 cm | 68,5 70 - 148,5 150 cm | DB0560070 | DB0560071 DB0560072 |
| 70 x 160 cm | 68,5 70 - 158,5 160 cm | DB0560080 | DB0560081 DB0560082 |
| 75 x 75 cm | 73,5 75 - 73,5 75 cm | DB0560100 | DB0560101 |
| 75 x 90 cm | 73,5 75 - 88,5 90 cm | DB0560110 | DB0560111 DB0560112 |
| 75 x 100 cm | 73,5 75 - 98,5 100 cm | DB0560120 | DB0560121 DB0560122 |
| 75 x 110 cm | 73,5 75 - 108,5 110 cm | DB0560130 | DB0560131 DB0560132 |
| 75 x 120 cm | 73,5 75 - 118,5 120 cm | DB0560140 | DB0560141 DB0560142 |
| 75 x 130 cm | 73,5 75 - 128,5 130 cm | DB0560150 | DB0560151 DB0560152 |
| 75 x 140 cm | 73,5 75 - 138,5 140 cm | DB0560160 | DB0560161 DB0560162 |
| 75 x 150 cm | 73,5 75 - 148,5 150 cm | DB0560170 | DB0560171 DB0560172 |
| 75 x 160 cm | 73,5 75 - 158,5 160 cm | DB0560180 | DB0560181 DB0560182 |
| 80 x 80 cm | 78,5 80 - 78,5 80 cm | DB0560200 | DB0560201 |
| 80 x 90 cm | 78,5 80 - 88,5 90 cm | DB0560210 | DB0560211 DB0560212 |
| 80 x 100 cm | 78,5 80 - 98,5 100 cm | DB0560220 | DB0560221 DB0560222 |
| 80 x 110 cm | 78,5 80 - 108,5 110 cm | DB0560230 | DB0560231 DB0560232 |
| 80 x 120 cm | 78,5 80 - 118,5 120 cm | DB0560240 | DB0560241 DB0560242 |
| 80 x 130 cm | 78,5 80 - 128,5 130 cm | DB0560250 | DB0560251 DB0560252 |
| 80 x 140 cm | 78,5 80 - 138,5 140 cm | DB0560260 | DB0560261 DB0560262 |
| 80 x 150 cm | 78,5 80 - 148,5 150 cm | DB0560270 | DB0560271 DB0560272 |
| 80 x 160 cm | 78,5 80 - 158,5 160 cm | DB0560280 | DB0560281 DB0560282 |
| 90 x 90 cm | 88,5 90 - 88,5 90 cm | DB0560400 | DB0560401 |
| 90 x 100 cm | 88,5 90 - 98,5 100 cm | DB0560410 | DB0560411 DB0560412 |
| 90 x 110 cm | 88,5 90 - 108,5 110 cm | DB0560420 | DB0560421 DB0560422 |
| 90 x 120 cm | 88,5 90 - 118,5 120 cm | DB0560430 | DB0560431 DB0560432 |
| 90 x 130 cm | 88,5 90 - 128,5 130 cm | DB0560440 | DB0560441 DB0560442 |
| 90 x 140 cm | 88,5 90 - 138,5 140 cm | DB0560450 | DB0560451 DB0560452 |
| 90 x 150 cm | 88,5 90 - 148,5 150 cm | DB0560460 | DB0560461 DB0560462 |
| 90 x 160 cm | 88,5 90 - 158,5 160 cm | DB0560470 | DB0560471 DB0560472 |

CHROMED | CHROMÉ | CROMADO





SHOWER ENCLOSURE
CHROMED FRAME
6 mm TEMPERED GLASS
TRANSPARENT GLASS
MAGNETIC CLOSE
190 cm HEIGHT

CABINE DE DOUCHE
PROFIL CHROMÉ
VERRE TREMPÉ 6 mm
VERRE TRANSPARENT
FERMETURE MAGNÉTIQUE
HAUTEUR 190 cm

MAMPARA DE DUCHA
PERFIL CROMO
VIDRIO TEMPLADO 6 mm
VIDRIO TRANSPARENTE
CIERRE MAGNÉTICO
ALTURA 190 cm

FRONT SHOWER PANEL
1 DOOR + 1 FIXED PANEL

PORTE DE DOUCHE
1 PORTE + 1 PANNEAU FIXE

MAMPARA FRONTAL DE DUCHA
1 PUERTA + 1 PANEL FIJO

| MEASURES MESURES MEDIDAS | ADJUSTMENT AJUSTEMENT AJUSTAMIENTO | REF. | REF. |
|--------------------------------|--|-----------|------------------------|
| 90 cm | 88,5 91,5 cm | DB0561100 | DB0561101 DB0561102 |
| 95 cm | 93,5 96,5 cm | DB0561105 | DB0561106 DB0561107 |
| 100 cm | 98,5 101,5 cm | DB0561110 | DB0561111 DB0561112 |
| 105 cm | 103,5 106,5 cm | DB0561115 | DB0561116 DB0561117 |
| 110 cm | 108,5 111,5 cm | DB0561120 | DB0561121 DB0561122 |
| 115 cm | 113,5 116,5 cm | DB0561125 | DB0561126 DB0561127 |
| 120 cm | 118,5 121,5 cm | DB0561130 | DB0561131 DB0561132 |
| 125 cm | 123,5 126,5 cm | DB0561135 | DB0561136 DB0561137 |
| 130 cm | 128,5 131,5 cm | DB0561140 | DB0561141 DB0561142 |
| 135 cm | 133,5 136,5 cm | DB0561145 | DB0561146 DB0561147 |
| 140 cm | 138,5 141,5 cm | DB0561150 | DB0561151 DB0561152 |
| 145 cm | 143,5 146,5 cm | DB0561155 | DB0561156 DB0561157 |
| 150 cm | 148,5 151,5 cm | DB0561160 | DB0561161 DB0561162 |
| 155 cm | 153,5 156,5 cm | DB0561165 | DB0561166 DB0561167 |
| 160 cm | 158,5 161,5 cm | DB0561170 | DB0561171 DB0561172 |

CHROMED
CHROMÉ
CROMADO

6 mm GLASS
TEMPERED GLASS
NO LOWER PROFILE
CHROMED UPPER WHEELS
190 cm HEIGHT

VERRE 6 mm
VERRE TREMPÉ
SANS PROFIL INFÉRIEUR
ROULETTES SUPÉRIEURES
CHROMÉES
HAUTEUR 190 cm

VIDRIO 6 mm
VIDRIO TEMPLADO
SIN PERFIL INFERIOR
ROLAMIENTOS SUPERIORES
CROMADOS
REVERSIBLE
ALTURA 190 cm

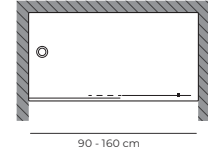

FRONT SHOWER PANEL
2 DOORS + 2 FIXED PANELS

PORTE DE DOUCHE
2 PORTES + 2 PANNEAUX FIXES

MAMPARA FRONTAL DE DUCHA
2 PUERTAS + 2 PANELES FIJOS

| MEASURES MESURES MEDIDAS | ADJUSTMENT AJUSTEMENT AJUSTAMIENTO | REF. | REF. |
|--------------------------------|--|-----------|-----------|
| 140 cm | 138,5 141,5 cm | DB0562100 | DB0562101 |
| 145 cm | 143,5 146,5 cm | DB0562105 | DB0562106 |
| 150 cm | 148,5 151,5 cm | DB0562110 | DB0562111 |
| 155 cm | 153,5 156,5 cm | DB0562115 | DB0562116 |
| 160 cm | 158,5 161,5 cm | DB0562120 | DB0562121 |
| 165 cm | 163,5 166,5 cm | DB0562125 | DB0562126 |
| 170 cm | 168,5 171,5 cm | DB0562130 | DB0562131 |
| 175 cm | 173,5 176,5 cm | DB0562135 | DB0562136 |
| 180 cm | 178,5 181,5 cm | DB0562140 | DB0562141 |
| 185 cm | 183,5 186,5 cm | DB0562145 | DB0562146 |
| 190 cm | 188,5 191,5 cm | DB0562150 | DB0562151 |
| 195 cm | 193,5 196,5 cm | DB0562155 | DB0562156 |
| 200 cm | 198,5 201,5 cm | DB0562160 | DB0562161 |

CHROMED
CHROMÉ
CROMADO

6 mm GLASS
TEMPERED GLASS
NO LOWER PROFILE
CHROMED UPPER WHEELS
190 cm HEIGHT

VERRE 6 mm
VERRE TREMPÉ
SANS PROFIL INFÉRIEUR
ROULETTES SUPÉRIEURES
CHROMÉES
HAUTEUR 190 cm

VIDRIO 6 mm
VIDRIO TEMPLADO
SIN PERFIL INFERIOR
ROLAMIENTOS SUPERIORES
CROMADOS
REVERSIBLE
ALTURA 190 cm

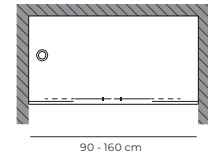

SIDE PANEL
PANNEAU LATÉRAL
PANEL LATERAL

| MEASURES MESURES MEDIDAS | ADJUSTMENT AJUSTEMENT AJUSTAMIENTO | REF. | REF. |
|--------------------------------|--|-----------|------------------------|
| 70 cm | 67,5 70 cm | DB0515000 | DB0515001 DB0515002 |
| 75 cm | 72,5 75 cm | DB0515005 | DB0515006 DB0515007 |
| 80 cm | 77,5 80 cm | DB0515010 | DB0515011 DB0515012 |
| 90 cm | 87,5 90 cm | DB0515020 | DB0515021 DB0515022 |

CHROMED
CHROMÉ
CROMADO

6 mm GLASS
TEMPERED GLASS
NO LOWER PROFILE
CHROMED UPPER WHEELS
190 cm HEIGHT

VERRE 6 mm
VERRE TREMPÉ
SANS PROFIL INFÉRIEUR
ROULETTES SUPÉRIEURES
CHROMÉES
HAUTEUR 190 cm

VIDRIO 6 mm
VIDRIO TEMPLADO
SIN PERFIL INFERIOR
ROLAMIENTOS SUPERIORES
CROMADOS
REVERSIBLE
ALTURA 190 cm





FRONT SHOWER PANEL
 W/1 DOOR + 1 FIXED PANEL
 CHROMED FRAME
 6 mm TEMPERED GLASS
 TRANSPARENT GLASS
 MAGNETIC CLOSE
 190 cm HEIGHT

PORTE DE DOUCHE
 A/1 PORTE + 1 PANNEAU FIXE
 PROFIL CHROME
 VERRE TREMPÉ 6 mm
 VERRE TRANSPARENT
 FERMETURE MAGNÉTIQUE
 HAUTEUR 190 cm

MAMPARA FRONTAL DE DUCHA
 C/1 PUERTA + 1 PANEL FIJO
 PERFIL CROMO
 VIDRIO TEMPLADO 6 mm
 VIDRIO TRANSPARENTE
 CIERRE MAGNÉTICO
 ALTURA 190 cm

8 mm GLASS
TEMPERED GLASS
100CM ROD
200 cm HEIGHT

VERRE 8 mm
VERRE TREMPÉ
TIGE DE 100CM
HAUTEUR 200 cm

VIDRIO 8 mm
VIDRIO TEMPLADO
BARRA DE 100CM
ALTURA 200 cm

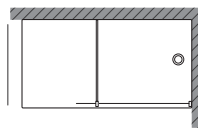

70 - 150 cm

SHOWER PANEL
PAROIS DE DOUCHE
PANEL DE DUCHA

| | MEASURES MESURES MEDIDAS | ADJUSTMENT AJUSTEMENT AJUSTAMIENTO | REF. | REF. | REF. |
|------------------------------|--------------------------------|--|-----------|-----------|-----------|
| CHROMED CHROMÉ CROMADO | 70 cm | 69 70 cm | DB0557000 | DB0557001 | - |
| | 80 cm | 79 80 cm | DB0557020 | DB0557021 | - |
| | 90 cm | 89 90 cm | DB0557030 | DB0557031 | - |
| | 100 cm | 99 100 cm | DB0557040 | DB0557041 | - |
| | 110 cm | 109 110 cm | DB0557050 | DB0557051 | - |
| | 120 cm | 119 120 cm | DB0557060 | DB0557061 | - |
| | 130 cm | 129 130 cm | DB0557070 | DB0557071 | - |
| | 140 cm | 139 140 cm | DB0557080 | DB0557081 | - |
| | 150 cm | 149 150 cm | DB0557090 | DB0557091 | - |
| | BLACK NOIR NEGRO | 70 cm | 69 70 cm | DB0557200 | DB0557201 |
| 80 cm | | 79 80 cm | DB0557220 | DB0557221 | DB0557222 |
| 90 cm | | 89 90 cm | DB0557230 | DB0557231 | DB0557232 |
| 100 cm | | 99 100 cm | DB0557240 | DB0557241 | DB0557242 |
| 110 cm | | 109 110 cm | DB0557250 | DB0557251 | DB0557252 |
| 120 cm | | 119 120 cm | DB0557260 | DB0557261 | DB0557262 |
| 130 cm | | 129 130 cm | DB0557270 | DB0557271 | DB0557272 |
| 140 cm | | 139 140 cm | DB0557280 | DB0557281 | DB0557282 |
| 150 cm | | 149 150 cm | DB0557290 | DB0557291 | DB0557292 |

IN CASE YOU WANT A 45° ROD YOU MUST MENTION IT WHEN YOU ORDER THE PRODUCT
SI VOUS VOULEZ LE PANNEAU AVEC LE TIGE À 45° VOUS DEVEZ LE MENTIONNER LORSQUE VOUS COMMANDEZ LE PRODUIT
EN CASO DE QUE DESEES LA BARRA A 45° DEBES MENCIONARLO AL ORDENAR EL PRODUCTO

SPECIAL MEASURES | MESURES SPÉCIALES | MEDIDAS ESPECIALES

| | MEASURES MESURES MEDIDAS | ADJUSTMENT AJUSTEMENT AJUSTAMIENTO | REF. | REF. | REF. |
|------------------------------|--------------------------------|--|-----------|-----------|-----------|
| CHROMED CHROMÉ CROMADO | 70 cm | 90 cm | DB0557100 | DB0557101 | - |
| | 90 cm | 120 cm | DB0557140 | DB0557141 | - |
| | 120 cm | 150 cm | DB0557180 | DB0557181 | - |
| BLACK NOIR NEGRO | 70 cm | 90 cm | DB0557300 | DB0557301 | DB0557302 |
| | 90 cm | 120 cm | DB0557340 | DB0557341 | DB0557342 |
| | 120 cm | 150 cm | DB0557380 | DB0557381 | DB0557382 |

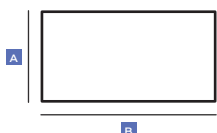

ADJUSTMENT PROFILES
PROFILS DE COMPENSATION
PERFILES DE COMPENSACIÓN

A B

CHROMED ALUMINIUM
ALUMINIUM CHROMÉ
ALUMINIO CROMADO

| MEASURES IN mm MESURES EN mm MEDIDAS EN mm | REF. |
|--|-----------|
| 15 15 | BC9005050 |
| 15 30 | BC9005051 |
| 20 20 | BC9005055 |
| 20 40 | BC9005056 |

SQUARE OR RECTANGULAR TUBULAR STRUCTURE: 200CM HEIGHT
STRUCTURE TUBULAIRE CARRÉE OU RECTANGULAIRE: HAUTEUR 200CM
ESTRUCTURA TUBULAR CUADRADA O RECTANGULAR: ALTURA 200CM





FIX

8 mm



FIXED SHOWER PANEL
 8 mm TEMPERED GLASS
 CHROMED FRAME
 TRANSPARENT GLASS
 100CM ROD
 200 cm HEIGHT

POROI DE DOUCHE FIXE
 VERRE TREMPÉ 8 mm
 PROFIL CHROMÉ
 VERRE TRANSPARENT
 TIGE DE 100CM
 HAUTEUR 200 cm

PANEL DE DUCHA FIJO
 VIDRIO TEMPLADO 8 mm
 PERFIL CROMO
 VIDRIO TRANSPARENTE
 BARRA DE 100CM
 ALTURA 200 cm

6 mm GLASS
TEMPERED GLASS
100CM ROD
200 cm HEIGHT

VERRE 6 mm
VERRE TREMPÉ
TIGE DE 100CM
HAUTEUR 200 cm

VIDRIO 6 mm
VIDRIO TEMPLADO
BARRA DE 100CM
ALTURA 200 cm

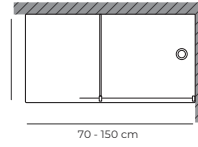

SHOWER PANEL
PAROIS DE DOUCHE
PANEL DE DUCHA

| | MEASURES MESURES MEDIDAS | ADJUSTMENT AJUSTEMENT AJUSTAMIENTO | REF. | REF. | REF. |
|------------------------------|--------------------------------|--|-----------|-----------|-----------|
| CHROMED CHROMÉ CROMADO | 70 cm | 69 70 cm | DB0556000 | DB0556001 | - |
| | 80 cm | 79 80 cm | DB0556020 | DB0556021 | - |
| | 90 cm | 89 90 cm | DB0556030 | DB0556031 | - |
| | 100 cm | 99 100 cm | DB0556040 | DB0556041 | - |
| | 110 cm | 109 110 cm | DB0556050 | DB0556051 | - |
| | 120 cm | 119 120 cm | DB0556060 | DB0556061 | - |
| BLACK NOIR NEGRO | 70 cm | 69 70 cm | DB0556200 | DB0556201 | DB0556202 |
| | 80 cm | 79 80 cm | DB0556220 | DB0556221 | DB0556222 |
| | 90 cm | 89 90 cm | DB0556230 | DB0556231 | DB0556232 |
| | 100 cm | 99 100 cm | DB0556240 | DB0556241 | DB0556242 |
| | 110 cm | 109 110 cm | DB0556250 | DB0556251 | DB0556252 |
| | 120 cm | 119 120 cm | DB0556260 | DB0556261 | DB0556262 |

IN CASE YOU WANT A 45° ROD YOU MUST MENTION IT WHEN YOU ORDER THE PRODUCT
SI VOUS VOULEZ LE PANNEAU AVEC LE TIGE À 45° VOUS DEVEZ LE MENTIONNER LORSQUE VOUS COMMANDEZ LE PRODUIT
EN CASO DE QUE DESEES LA BARRA A 45° DEBES MENCIONARLO AL ORDENAR EL PRODUCTO

SPECIAL MEASURES | MESURES SPÉCIALES | MEDIDAS ESPECIALES

| | MEASURES MESURES MEDIDAS | ADJUSTMENT AJUSTEMENT AJUSTAMIENTO | REF. | REF. | REF. |
|------------------------------|--------------------------------|--|-----------|-----------|-----------|
| CHROMED CHROMÉ CROMADO | 70 cm | 90 cm | DB0556100 | DB0556101 | - |
| | 91 cm | 120 cm | DB0556140 | DB0556141 | - |
| BLACK NOIR NEGRO | 70 cm | 90 cm | DB0556300 | DB0556301 | DB0556302 |
| | 91 cm | 120 cm | DB0556340 | DB0556341 | DB0556342 |

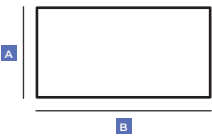

**ADJUSTMENT PROFILES
PROFILS DE COMPENSATION
PERFILES DE COMPENSACIÓN**

A B

CHROMED ALUMINIUM
ALUMINIUM CHROMÉ
ALUMINIO CROMADO

| MEASURES IN mm MESURES EN mm MEDIDAS EN mm | REF. |
|--|-----------|
| 15 15 | BC9005050 |
| 15 30 | BC9005051 |
| 20 20 | BC9005055 |
| 20 40 | BC9005056 |

SQUARE OR RECTANGULAR TUBULAR STRUCTURE: 200CM HEIGHT
STRUCTURE TUBULAIRE CARRÉE OU RECTANGULAIRE: HAUTEUR 200CM
ESTRUCTURA TUBULAR CUADRADA O RECTANGULAR: ALTURA 200CM

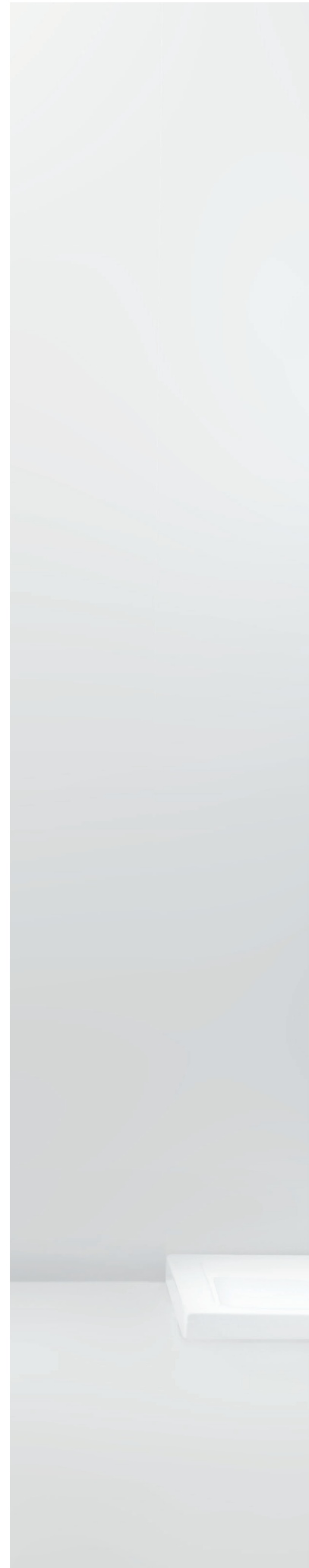



FIX

6 mm



FIXED SHOWER PANEL
 6 mm TEMPERED GLASS
 CHROMED FRAME
 SERIGRAPHED GLASS
 100CM ROD
 200 cm HEIGHT

POROI DE DOUCHE FIXE
 VERRE TREMPÉ 6 mm
 PROFIL CHROMÉ
 VERRE SÉRIGRAPHIÉ
 TIGE DE 100CM
 HAUTEUR 200 cm

PANEL DE DUCHA FIJO
 VIDRIO TEMPLADO 6 mm
 PERFIL CROMO
 VIDRIO SERIGRAFADO
 BARRA DE 100CM
 ALTURA 200 cm



6 mm GLASS
TEMPERED GLASS
EASY
DISASSEMBLY
REVERSIBLE
190 cm HEIGHT

VERRE 6 mm
VERRE TREMPÉ
DÉMONTAGE
FACILE
REVERSIBLE
HAUTEUR 190 cm

VIDRIO 6 mm
VIDRIO TEMPLADO
DESMONTAJE FÁCIL
REVERSIBLE
ALTURA 190 cm

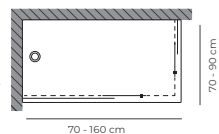

SHOWER ENCLOSURE
CABINE DE DOUCHE
MAMPARA DE DUCHA



| MEASURES MESURES MEDIDAS | ADJUSTMENT AJUSTEMENT AJUSTAMIENTO | REF. | REF. |
|--------------------------------|--|-----------|-----------|
| 70 x 70 cm | 67,5 69 - 67,5 69 cm | DB0570000 | DB0570001 |
| 70 x 90 cm | 67,5 69 - 87,5 89 cm | DB0570010 | DB0570011 |
| 70 x 100 cm | 67,5 69 - 97,5 99 cm | DB0570020 | DB0570021 |
| 70 x 110 cm | 67,5 69 - 107,5 109 cm | DB0570030 | DB0570031 |
| 70 x 120 cm | 67,5 69 - 117,5 119 cm | DB0570040 | DB0570041 |
| 70 x 130 cm | 67,5 69 - 127,5 129 cm | DB0570050 | DB0570051 |
| 70 x 140 cm | 67,5 69 - 137,5 139 cm | DB0570060 | DB0570061 |
| 70 x 150 cm | 67,5 69 - 147,5 149 cm | DB0570070 | DB0570071 |
| 70 x 160 cm | 67,5 69 - 157,5 159 cm | DB0570080 | DB0570081 |
| CHROMED CROMADO | | | |
| 75 x 75 cm | 72,5 74 - 72,5 74 cm | DB0570100 | DB0570101 |
| 75 x 90 cm | 72,5 74 - 87,5 89 cm | DB0570110 | DB0570111 |
| 75 x 100 cm | 72,5 74 - 97,5 99 cm | DB0570120 | DB0570121 |
| 75 x 110 cm | 72,5 74 - 107,5 109 cm | DB0570130 | DB0570131 |
| 75 x 120 cm | 72,5 74 - 117,5 119 cm | DB0570140 | DB0570141 |
| 75 x 130 cm | 72,5 74 - 127,5 129 cm | DB0570150 | DB0570151 |
| 75 x 140 cm | 72,5 74 - 137,5 139 cm | DB0570160 | DB0570161 |
| 75 x 150 cm | 72,5 74 - 147,5 149 cm | DB0570170 | DB0570171 |
| 75 x 160 cm | 72,5 74 - 157,5 159 cm | DB0570180 | DB0570181 |
| 80 x 80 cm | 77,5 79 - 77,5 79 cm | DB0570200 | DB0570201 |
| 80 x 90 cm | 77,5 79 - 87,5 89 cm | DB0570210 | DB0570211 |
| 80 x 100 cm | 77,5 79 - 97,5 99 cm | DB0570220 | DB0570221 |
| 80 x 110 cm | 77,5 79 - 107,5 109 cm | DB0570230 | DB0570231 |
| 80 x 120 cm | 77,5 79 - 117,5 119 cm | DB0570240 | DB0570241 |
| 80 x 130 cm | 77,5 79 - 127,5 129 cm | DB0570250 | DB0570251 |
| 80 x 140 cm | 77,5 79 - 137,5 139 cm | DB0570260 | DB0570261 |
| 80 x 150 cm | 77,5 79 - 147,5 149 cm | DB0570270 | DB0570271 |
| 80 x 160 cm | 77,5 79 - 157,5 159 cm | DB0570280 | DB0570281 |
| 90 x 90 cm | 87,5 89 - 87,5 89 cm | DB0570400 | DB0570401 |
| 90 x 100 cm | 87,5 89 - 97,5 99 cm | DB0570410 | DB0570411 |
| 90 x 110 cm | 87,5 89 - 107,5 109 cm | DB0570420 | DB0570421 |
| 90 x 120 cm | 87,5 89 - 117,5 119 cm | DB0570430 | DB0570431 |
| 90 x 130 cm | 87,5 89 - 127,5 129 cm | DB0570440 | DB0570441 |
| 90 x 140 cm | 87,5 89 - 137,5 139 cm | DB0570450 | DB0570451 |
| 90 x 150 cm | 87,5 89 - 147,5 149 cm | DB0570460 | DB0570461 |
| 90 x 160 cm | 87,5 89 - 157,5 159 cm | DB0570470 | DB0570471 |

SHOWER ENCLOSURE
CHROMED FRAME
6 mm TEMPERED GLASS
SERIGRAPHED GLASS
REVERSIBLE
190 cm HEIGHT

CABINE DE DOUCHE
PROFIL CROMÉ
VERRE TREMPÉ 6 mm
VERRE SÉRIGRAPHIÉ
REVERSIBLE
HAUTEUR 190 cm

MAMPARA DE DUCHA
PERFIL CROMO
VIDRIO TEMPLADO 6 mm
VIDRIO SERIGRAFADO
REVERSIBLE
ALTURA 190 cm





VELA



ctesi



FRONT SHOWER PANEL
W/ 1 DOOR
+ 1 FIXED PANEL
CHROMED FRAME
6 mm TEMPERED GLASS
SERIGRAPHED GLASS
REVERSIBLE
190 cm HEIGHT

PORTE DE DOUCHE
A/ 1 PORTE
+ 1 PANNEAU FIXE
PROFIL CHROMÉ
VERRE TREMPÉ 6 mm
VERRE SÉRIGRAPHIÉ
RÉVERSIBLE
HAUTEUR 190 cm

MAMPARA FRONTAL
DE DUCHA C/ 1 PUERTA
+ 1 PANEL FIJO
PERFIL CROMO
VIDRIO TEMPLADO 6 mm
VIDRIO SERIGRAFADO
REVERSIBLE
ALTURA 190 cm

FRONT SHOWER PANEL
W/ 2 DOORS
+ 2 FIXED PANELS
CHROMED FRAME
6 mm TEMPERED GLASS
SERIGRAPHED GLASS
REVERSIBLE
190 cm HEIGHT

PORTE DE DOUCHE
A/ 2 PORTES
+ 2 PANNEAUX FIXES
PROFIL CHROMÉ
VERRE TREMPÉ 6 mm
VERRE SÉRIGRAPHIÉ
RÉVERSIBLE
HAUTEUR 190 cm

MAMPARA FRONTAL
DE DUCHA C/ 2 PUERTAS
+ 2 PANELES FIJOS
PERFIL CROMO
VIDRIO TEMPLADO 6 mm
VIDRIO SERIGRAFADO
REVERSIBLE
ALTURA 190 cm

6 mm GLASS
TEMPERED GLASS
EASY
DISASSEMBLY
190 cm HEIGHT

VERRE 6 mm
VERRE TREMPÉ
DEMONTAGE
FACILE
HAUTEUR 190 cm

VIDRIO 6 mm
VIDRIO TEMPLADO
DESMONTAJE FÁCIL
ALTURA 190 cm

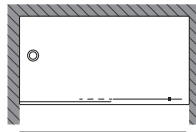

90 - 160 cm

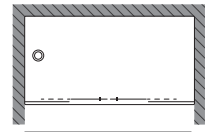

140 - 200 cm

FRONT SHOWER PANEL
1 DOOR + 1 FIXED PANEL

PORTE DE DOUCHE
1 PORTE + 1 PANNEAU FIXE

MAMPARA FRONTAL DE DUCHA
1 PUERTA + 1 PANEL FIJO

FRONT SHOWER PANEL
2 DOORS + 2 FIXED PANELS

PORTE DE DOUCHE
2 PORTES + 2 PANNEAUX FIXES

MAMPARA FRONTAL DE DUCHA
2 PUERTAS + 2 PANELES FIJOS



| MEASURES MESURES MEDIDAS | ADJUSTMENT AJUSTEMENT AJUSTAMIENTO | REF. | REF. |
|--------------------------------|--|-----------|-----------|
| 90 cm | 88 91 cm | DB0573100 | DB0573101 |
| 95 cm | 93 96 cm | DB0573105 | DB0573106 |
| 100 cm | 98 101 cm | DB0573110 | DB0573111 |
| 105 cm | 103 106 cm | DB0573115 | DB0573116 |
| 110 cm | 108 111 cm | DB0573120 | DB0573121 |
| 115 cm | 113 116 cm | DB0573125 | DB0573126 |
| 120 cm | 118 121 cm | DB0573130 | DB0573131 |
| 125 cm | 123 126 cm | DB0573135 | DB0573136 |
| 130 cm | 128 131 cm | DB0573140 | DB0573141 |
| 135 cm | 133 136 cm | DB0573145 | DB0573146 |
| 140 cm | 138 141 cm | DB0573150 | DB0573151 |
| 145 cm | 143 146 cm | DB0573155 | DB0573156 |
| 150 cm | 148 151 cm | DB0573160 | DB0573161 |
| 155 cm | 153 156 cm | DB0573165 | DB0573166 |
| 160 cm | 158 161 cm | DB0573170 | DB0573171 |

CHROMED
CHROMÉ
CROMADO

| MEASURES MESURES MEDIDAS | ADJUSTMENT AJUSTEMENT AJUSTAMIENTO | REF. | REF. |
|--------------------------------|--|-----------|-----------|
| 140 cm | 138 141 cm | DB0574000 | DB0574001 |
| 145 cm | 143 146 cm | DB0574005 | DB0574006 |
| 150 cm | 148 151 cm | DB0574010 | DB0574011 |
| 155 cm | 153 156 cm | DB0574015 | DB0574016 |
| 160 cm | 158 161 cm | DB0574020 | DB0574021 |
| 165 cm | 163 166 cm | DB0574025 | DB0574026 |
| 170 cm | 168 171 cm | DB0574030 | DB0574031 |
| 175 cm | 173 176 cm | DB0574035 | DB0574036 |
| 180 cm | 178 181 cm | DB0574040 | DB0574041 |
| 185 cm | 183 186 cm | DB0574045 | DB0574046 |
| 190 cm | 188 191 cm | DB0574050 | DB0574051 |
| 195 cm | 193 196 cm | DB0574055 | DB0574056 |
| 200 cm | 198 201 cm | DB0574060 | DB0574061 |

SIDE PANEL
PANNEAU LATÉRAL
PANEL LATERAL



| MEASURES MESURES MEDIDAS | ADJUSTMENT AJUSTEMENT AJUSTAMIENTO | REF. | REF. |
|--------------------------------|--|-----------|----------------------|
| 70 cm | 68,5 70 cm | DB0575100 | DB0575101 DB0575102 |
| 75 cm | 73,5 75 cm | DB0575105 | DB0575106 DB0575107 |
| 80 cm | 78,5 80 cm | DB0575110 | DB0575111 DB0575112 |
| 90 cm | 88,5 90 cm | DB0575120 | DB0575121 DB0575122 |

CHROMED
CHROMÉ
CROMADO



FRONT BATH PANEL
W/ 1 DOOR
+ 1 FIXED PANEL
CHROMED FRAME
6 mm TEMPERED GLASS
TRANSPARENT GLASS
MAGNETIC CLOSE
140 cm HEIGHT

PORTE DE BAIGNOIRE
A/ 1 PORTE
+ 1 PANNEAU FIXE
PROFIL CHROMÉ
VERRE TREMPÉ 6 mm
VERRE TRANSPARENT
FERMETURE MAGNÉTIQUE
HAUTEUR 140 cm

MAMPARA FRONTAL
DE BAÑO C/ 1 PUERTA
+ 1 PANEL FIJO
PERFIL CROMO
VIDRIO TEMPLADO 6 mm
VIDRIO TRANSPARENTE
CIERRE MAGNÉTICO
ALTURA 140 cm

FRONT BATH PANEL
W/ 2 DOORS
+ 2 FIXED PANELS
CHROMED FRAME
6 mm TEMPERED GLASS
SERIGRAPHED GLASS
MAGNETIC CLOSE
140 cm HEIGHT

PORTE DE BAIGNOIRE
A/ 2 PORTES
+ 2 PANNEAUX FIXES
PROFIL CHROMÉ
VERRE TREMPÉ 6 mm
VERRE SÉRIGRAPHIÉ
FERMETURE MAGNÉTIQUE
HAUTEUR 140 cm

MAMPARA FRONTAL
DE BAÑO C/ 2 PUERTAS
+ 2 PANELES FIJOS
PERFIL CROMO
VIDRIO TEMPLADO 6 mm
VIDRIO SERIGRAFADO
CIERRE MAGNÉTICO
ALTURA 140 cm

6 mm GLASS
TEMPERED GLASS
MAGNETIC CLOSE
140 cm HEIGHT

VERRE 6 mm
VERRE TREMPÉ
FERMETURE MAGNÉTIQUE
HAUTEUR 140 cm

VIDRIO 6 mm
VIDRIO TEMPLADO
CIERRE MAGNÉTICO
ALTURA 140 cm

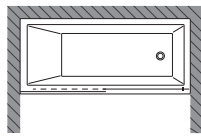

140 - 200 cm

FRONT BATH PANEL
1 DOOR + 1 FIXED PANEL

PORTE DE BAIGNOIRE
1 PORTE + 1 PANNEAU FIXE

MAMPARA FRONTAL DE BAÑO
1 PUERTA + 1 PANEL FIJO

FRONT BATH PANEL
2 DOORS + 2 FIXED PANELS

PORTE DE BAIGNOIRE
2 PORTES + 2 PANNEAUX FIXES

MAMPARA FRONTAL DE BAÑO
2 PUERTAS + 2 PANELES FIJOS

| MEASURES MESURES MEDIDAS | ADJUSTMENT AJUSTEMENT AJUSTAMIENTO | REF. | REF. |
|--------------------------------|--|-----------|-----------|
| 140 cm | 138 141 cm | DB0573500 | DB0573501 |
| 145 cm | 143 146 cm | DB0573505 | DB0573506 |
| 150 cm | 148 151 cm | DB0573510 | DB0573511 |
| 155 cm | 153 156 cm | DB0573515 | DB0573516 |
| 160 cm | 158 161 cm | DB0573520 | DB0573521 |
| 165 cm | 163 166 cm | DB0573525 | DB0573526 |
| 170 cm | 168 171 cm | DB0573530 | DB0573531 |
| 175 cm | 173 176 cm | DB0573535 | DB0573536 |
| 180 cm | 178 181 cm | DB0573540 | DB0573541 |
| 185 cm | 183 186 cm | DB0573545 | DB0573546 |
| 190 cm | 188 191 cm | DB0573550 | DB0573551 |
| 195 cm | 193 196 cm | DB0573555 | DB0573556 |
| 200 cm | 198 201 cm | DB0573560 | DB0573561 |

| MEASURES MESURES MEDIDAS | ADJUSTMENT AJUSTEMENT AJUSTAMIENTO | REF. | REF. |
|--------------------------------|--|-----------|-----------|
| 140 cm | 138 141 cm | DB0574500 | DB0574501 |
| 145 cm | 143 146 cm | DB0574505 | DB0574506 |
| 150 cm | 148 151 cm | DB0574510 | DB0574511 |
| 155 cm | 153 156 cm | DB0574515 | DB0574516 |
| 160 cm | 158 161 cm | DB0574520 | DB0574521 |
| 165 cm | 163 166 cm | DB0574525 | DB0574526 |
| 170 cm | 168 171 cm | DB0574530 | DB0574531 |
| 175 cm | 173 176 cm | DB0574535 | DB0574536 |
| 180 cm | 178 181 cm | DB0574540 | DB0574541 |
| 185 cm | 183 186 cm | DB0574545 | DB0574546 |
| 190 cm | 188 191 cm | DB0574550 | DB0574551 |
| 195 cm | 193 196 cm | DB0574555 | DB0574556 |
| 200 cm | 198 201 cm | DB0574560 | DB0574561 |

SIDE PANEL
PANNEAU LATÉRAL
PANEL LATERAL

| MEASURES MESURES MEDIDAS | ADJUSTMENT AJUSTEMENT AJUSTAMIENTO | REF. | REF. |
|--------------------------------|--|-----------|------------------------|
| 70 cm | 68,5 70 cm | DB0575500 | DB0575501 DB0575502 |
| 75 cm | 73,5 75 cm | DB0575505 | DB0575506 DB0575507 |
| 80 cm | 78,5 80 cm | DB0575510 | DB0575511 DB0575512 |

CHROMED
CHROMÉ
CROMADO





FRONT SHOWER PANEL
W/ 2 DOORS + 1 FIXED
PANEL + 1 SIDE PANEL
4 mm TEMPERED GLASS
TRANSPARENT GLASS
MAGNETIC CLOSE
REVERSIBLE
185 cm HEIGHT

PORTE DE DOUCHE
A/ 2 PORTES + 1 PANNEAU
FIXE + 1 PANNEAU LATÉRAL
VERRE TREMPÉ 4 mm
VERRE TRANSPARENT
FERMETURE MAGNÉTIQUE
RÉVERSIBLE
HAUTEUR 185 cm

MAMPARA FRONTAL DE DUCHA
C/ 2 PUERTAS + 1 PANEL FIJO
+ 1 PANEL LATERAL
VIDRIO TEMPLADO 4 mm
VIDRIO TRANSPARENTE
CIERRE MAGNÉTICO
REVERSIBLE
ALTURA 185 cm

FRONT SHOWER PANEL
W/ 2 DOORS
+ 1 FIXED PANEL
4 mm TEMPERED GLASS
SERIGRAPHED GLASS
MAGNETIC CLOSE
REVERSIBLE
185 cm HEIGHT

PORTE DE DOUCHE
A/ 2 PORTES
+ 1 PANNEAU FIXE
VERRE TREMPÉ 4 mm
VERRE SÉRIGRAPHIÉ
FERMETURE MAGNÉTIQUE
RÉVERSIBLE
HAUTEUR 185 cm

MAMPARA FRONTAL
DE DUCHA C/ 2 PUERTAS
+ 1 PANEL FIJO
VIDRIO TEMPLADO 4 mm
VIDRIO SERIGRAFADO
CIERRE MAGNÉTICO
REVERSIBLE
ALTURA 185 cm



FRONT SHOWER PANEL
2 DOORS + 1 FIXED PANEL

PORTE DE DOUCHE
2 PORTES + 1 PANNEAU FIXE

MAMPARA FRONTAL DE DUCHA
2 PUERTAS + 1 PANEL FIJO

CHROMED
CHROMÉ
CROMADO

| MEASURES MESURES MEDIDAS | ADJUSTMENT AJUSTEMENT AJUSTAMIENTO | REF. | REF. |
|--------------------------------|--|-----------|-----------|
| 80 cm | 77 82 cm | DB0504000 | DB0504001 |
| 85 cm | 82 87 cm | DB0504005 | DB0504006 |
| 90 cm | 87 92 cm | DB0504010 | DB0504011 |
| 95 cm | 92 97 cm | DB0504015 | DB0504016 |
| 100 cm | 97 102 cm | DB0504020 | DB0504021 |
| 105 cm | 102 107 cm | DB0504025 | DB0504026 |
| 110 cm | 107 112 cm | DB0504030 | DB0504031 |
| 115 cm | 112 117 cm | DB0504035 | DB0504036 |
| 120 cm | 117 122 cm | DB0504040 | DB0504041 |
| 125 cm | 122 127 cm | DB0504045 | DB0504046 |
| 130 cm | 127 132 cm | DB0504050 | DB0504051 |
| 135 cm | 132 137 cm | DB0504055 | DB0504056 |
| 140 cm | 137 142 cm | DB0504060 | DB0504061 |
| 145 cm | 142 147 cm | DB0504065 | DB0504066 |
| 150 cm | 147 152 cm | DB0504070 | DB0504071 |
| 155 cm | 152 157 cm | DB0504075 | DB0504076 |
| 160 cm | 157 162 cm | DB0504080 | DB0504081 |

WHITE
BLANC
BLANCO

FRONT SHOWER PANEL
2 DOORS + 1 FIXED PANEL

PORTE DE DOUCHE
2 PORTES + 1 PANNEAU FIXE

MAMPARA FRONTAL DE DUCHA
2 PUERTAS + 1 PANEL FIJO

| MEASURES MESURES MEDIDAS | ADJUSTMENT AJUSTEMENT AJUSTAMIENTO | REF. | REF. |
|--------------------------------|--|-----------|-----------|
| 80 cm | 77 82 cm | DB0524001 | DB0524002 |
| 85 cm | 82 87 cm | DB0524006 | DB0524007 |
| 90 cm | 87 92 cm | DB0524011 | DB0524012 |
| 95 cm | 92 97 cm | DB0524016 | DB0524017 |
| 100 cm | 97 102 cm | DB0524021 | DB0524022 |
| 105 cm | 102 107 cm | DB0524026 | DB0524027 |
| 110 cm | 107 112 cm | DB0524031 | DB0524032 |
| 115 cm | 112 117 cm | DB0524036 | DB0524037 |
| 120 cm | 117 122 cm | DB0524041 | DB0524042 |
| 125 cm | 122 127 cm | DB0524046 | DB0524047 |
| 130 cm | 127 132 cm | DB0524051 | DB0524052 |
| 135 cm | 132 137 cm | DB0524056 | DB0524057 |
| 140 cm | 137 142 cm | DB0524061 | DB0524062 |
| 145 cm | 142 147 cm | DB0524066 | DB0524067 |
| 150 cm | 147 152 cm | DB0524071 | DB0524072 |
| 155 cm | 152 157 cm | DB0524076 | DB0524077 |
| 160 cm | 157 162 cm | DB0524081 | DB0524082 |

SIDE PANEL
PANNEAU LATÉRAL
PANEL LATERAL

CHROMED
CHROMÉ
CROMADO

| MEASURES MESURES MEDIDAS | ADJUSTMENT AJUSTEMENT AJUSTAMIENTO | REF. | REF. |
|--------------------------------|--|-----------|-----------|
| 70 cm | 67,5 70 cm | DB0504600 | DB0504621 |
| 75 cm | 72,5 75 cm | DB0504605 | DB0504626 |
| 80 cm | 77,5 80 cm | DB0504610 | DB0504631 |
| 90 cm | 87,5 90 cm | DB0504615 | DB0504636 |

SIDE PANEL
PANNEAU LATÉRAL
PANEL LATERAL

WHITE
BLANC
BLANCO

| MEASURES MESURES MEDIDAS | ADJUSTMENT AJUSTEMENT AJUSTAMIENTO | REF. | REF. |
|--------------------------------|--|-----------|-----------|
| 70 cm | 67,5 70 cm | DB0524501 | DB0524502 |
| 75 cm | 72,5 75 cm | DB0524506 | DB0524507 |
| 80 cm | 77,5 80 cm | DB0524511 | DB0524512 |
| 90 cm | 87,5 90 cm | DB0524516 | DB0524517 |



FRONT BATH PANEL
W/2 DOORS + 1 FIXED
PANEL + 1 SIDE PANEL
4 mm TEMPERED GLASS
TRANSPARENT GLASS
MAGNETIC CLOSE
REVERSIBLE
140 cm HEIGHT

PORTE DE BAIGNOIRE
A/ 2 PORTES + 1 PANNEAU
FIXE + 1 PANNEAU LATÉRAL
VERRE TREMPÉ 4 mm
VERRE TRANSPARENT
FERMETURE MAGNÉTIQUE
RÉVERSIBLE
HAUTEUR 140 cm

MAMPARA FRONTAL DE BAÑO
C/ 2 PUERTAS + 1 PANEL FIJO
+ 1 PANEL LATERAL
VIDRIO TEMPLADO 4 mm
VIDRIO TRANSPARENTE
CIERRE MAGNÉTICO
REVERSIBLE
ALTURA 140 cm

FRONT BATH PANEL
W/ 2 DOORS
+ 1 FIXED PANEL
4 mm TEMPERED GLASS
SERIGRAPHED GLASS
MAGNETIC CLOSE
REVERSIBLE
140 cm HEIGHT

PORTE DE BAIGNOIRE
A/ 2 PORTES
+ 1 PANNEAU FIXE
VERRE TREMPÉ 4 mm
VERRE SÉRIGRAPHIÉ
FERMETURE MAGNÉTIQUE
RÉVERSIBLE
HAUTEUR 140 cm

MAMPARA FRONTAL
DE BAÑO C/ 2 PUERTAS
+ 1 PANEL FIJO
VIDRIO TEMPLADO 4 mm
VIDRIO SERIGRAFADO
CIERRE MAGNÉTICO
REVERSIBLE
ALTURA 140 cm



4 mm GLASS
TEMPERED
GLASS
MAGNETIC CLOSE
140 cm HEIGHT

VERRE 4 mm
VERRE TREMPÉ
FERMETURE
MAGNÉTIQUE
HAUTEUR 140 cm

VIDRIO 4 mm
VIDRIO TEMPLADO
CIERRE
MAGNÉTICO
ALTURA 140 cm

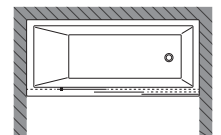

4 mm GLASS
TEMPERED
GLASS
MAGNETIC CLOSE
140 cm HEIGHT

VERRE 4 mm
VERRE TREMPÉ
FERMETURE
MAGNÉTIQUE
HAUTEUR 140 cm

VIDRIO 4 mm
VIDRIO
TEMPLADO
CIERRE
MAGNÉTICO
ALTURA 140 cm

FRONT SHOWER PANEL
2 DOORS + 1 FIXED PANEL

PORTE DE DOUCHE
2 PORTES + 1 PANNEAU FIXE

MAMPARA FRONTAL DE DOCHA
2 PUERTAS + 1 PANEL FIJO

| MEASURES MESURES MEDIDAS | ADJUSTMENT AJUSTEMENT AJUSTAMIENTO | REF. | REF. |
|--------------------------------|--|-----------|-----------|
| 150 cm | 147 152 cm | DB0505000 | DB0505001 |
| 155 cm | 152 157 cm | DB0505005 | DB0505006 |
| 160 cm | 157 162 cm | DB0505010 | DB0505011 |
| 165 cm | 162 167 cm | DB0505015 | DB0505016 |
| 170 cm | 167 172 cm | DB0505020 | DB0505021 |
| 175 cm | 172 177 cm | DB0505025 | DB0505026 |
| 180 cm | 177 182 cm | DB0505030 | DB0505031 |
| 185 cm | 182 187 cm | DB0505035 | DB0505036 |
| 190 cm | 187 192 cm | DB0505040 | DB0505041 |
| 195 cm | 192 197 cm | DB0505045 | DB0505046 |
| 200 cm | 197 202 cm | DB0505050 | DB0505051 |

CHROMED
CHROMÉ
CROMADO

FRONT SHOWER PANEL
2 DOORS + 1 FIXED PANEL

PORTE DE DOUCHE
2 PORTES + 1 PANNEAU FIXE

MAMPARA FRONTAL DE DOCHA
2 PUERTAS + 1 PANEL FIJO

| MEASURES MESURES MEDIDAS | ADJUSTMENT AJUSTEMENT AJUSTAMIENTO | REF. | REF. |
|--------------------------------|--|-----------|-----------|
| 150 cm | 147 152 cm | DB0525001 | DB0525002 |
| 155 cm | 152 157 cm | DB0525006 | DB0525007 |
| 160 cm | 157 162 cm | DB0525011 | DB0525012 |
| 165 cm | 162 167 cm | DB0525016 | DB0525017 |
| 170 cm | 167 172 cm | DB0525021 | DB0525022 |
| 175 cm | 172 177 cm | DB0525026 | DB0525027 |
| 180 cm | 177 182 cm | DB0525031 | DB0525032 |
| 185 cm | 182 187 cm | DB0525036 | DB0525037 |
| 190 cm | 187 192 cm | DB0525041 | DB0525042 |
| 195 cm | 192 197 cm | DB0525046 | DB0525047 |
| 200 cm | 197 202 cm | DB0525051 | DB0525052 |

WHITE
BLANC
BLANCO

SIDE PANEL
PANNEAU LATÉRAL
PANEL LATERAL

| MEASURES MESURES MEDIDAS | ADJUSTMENT AJUSTEMENT AJUSTAMIENTO | REF. | REF. |
|--------------------------------|--|-----------|-----------|
| 70 cm | 67,5 70 cm | DB0505500 | DB0505501 |
| 75 cm | 72,5 75 cm | DB0505505 | DB0505506 |
| 80 cm | 77,5 80 cm | DB0505510 | DB0505511 |

CHROMED
CHROMÉ
CROMADO

SIDE PANEL
PANNEAU LATÉRAL
PANEL LATERAL

| MEASURES MESURES MEDIDAS | ADJUSTMENT AJUSTEMENT AJUSTAMIENTO | REF. | REF. |
|--------------------------------|--|-----------|-----------|
| 70 cm | 67,5 70 cm | DB0525501 | DB0525502 |
| 75 cm | 72,5 75 cm | DB0525506 | DB0525507 |
| 80 cm | 77,5 80 cm | DB0525511 | DB0525512 |

WHITE
BLANC
BLANCO





SHOWER ENCLOSURE
CABINE DE DOUCHE
MAMPARA DE DUCHA



SHOWER ENCLOSURE
4 mm TEMPERED GLASS
SERIGRAPHED GLASS
MAGNETIC CLOSE
REVERSIBLE
185 cm HEIGHT

CABINE DE DOUCHE
VERRE TREMPÉ 4 mm
VERRE SÉRIGRAPHIÉ
FERMETURE MAGNÉTIQUE
RÉVERSIBLE
HAUTEUR 185 cm

MAMPARA DE DUCHA
VIDRIO TEMPLADO 4 mm
VIDRIO SERIGRAFADO
CIERRE MAGNÉTICO
REVERSIBLE
ALTURA 185 cm

WHITE
BLANC
BLANCO

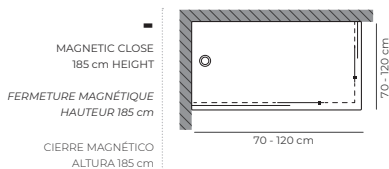

| MEASURES MESURES MEDIDAS | ADJUSTMENT AJUSTEMENT AJUSTAMIENTO | REF. | REF. |
|--------------------------------|--|-----------|-----------|
| 70 x 70 cm | 60 70 - 60 70 cm | DB0520001 | DB0520002 |
| 70 x 80 cm | 60 70 - 70 80 cm | DB0520031 | DB0520032 |
| 70 x 90 cm | 60 70 - 80 90 cm | DB0520036 | DB0520037 |
| 70 x 100 cm | 60 70 - 90 100 cm | DB0520041 | DB0520042 |
| 70 x 110 cm | 60 70 - 100 110 cm | DB0520046 | DB0520047 |
| 70 x 120 cm | 60 70 - 110 120 cm | DB0520051 | DB0520052 |
| 80 x 80 cm | 70 80 - 70 80 cm | DB0520006 | DB0520007 |
| 80 x 90 cm | 70 80 - 80 90 cm | DB0520056 | DB0520057 |
| 80 x 100 cm | 70 80 - 90 100 cm | DB0520061 | DB0520062 |
| 80 x 110 cm | 70 80 - 100 110 cm | DB0520066 | DB0520067 |
| 80 x 120 cm | 70 80 - 110 120 cm | DB0520071 | DB0520072 |
| 90 x 90 cm | 80 90 - 80 90 cm | DB0520011 | DB0520012 |
| 90 x 100 cm | 80 90 - 90 100 cm | DB0520076 | DB0520077 |
| 90 x 110 cm | 80 90 - 100 110 cm | DB0520081 | DB0520082 |
| 90 x 120 cm | 80 90 - 110 120 cm | DB0520086 | DB0520087 |
| 100 x 100 cm | 90 100 - 90 100 cm | DB0520016 | DB0520017 |
| 100 x 110 cm | 90 100 - 100 110 cm | DB0520091 | DB0520092 |
| 100 x 120 cm | 90 100 - 110 120 cm | DB0520096 | DB0520097 |
| 110 x 110 cm | 100 110 - 100 110 cm | DB0520021 | DB0520022 |
| 110 x 120 cm | 100 110 - 110 120 cm | DB0520101 | DB0520102 |
| 120 x 120 cm | 110 110 - 110 120 cm | DB0520026 | DB0520027 |

SPECIAL MEASURES ADD 25% TO THE PREVIOUS MEASURE PRICE
DES MESURES SPECIALES AJOUTENT 25% AU PRIX DE LA MESURE PRÉCÉDENTE
MEDIDAS ESPECIALES AUMENTAN UN 25% AL PRECIO DE LA MEDIDA ANTERIOR



SHOWER ENCLOSURE
CABINE DE DOUCHE
MAMPARA DE DUCHA



SHOWER ENCLOSURE
4 mm TEMPERED GLASS
TRANSPARENT GLASS
MAGNETIC CLOSE
REVERSIBLE
185 cm HEIGHT

CABINE DE DOUCHE
VERRE TREMPÉ 4 mm
VERRE TRANSPARENT
FERMETURE MAGNÉTIQUE
RÉVERSIBLE
HAUTEUR 185 cm

MAMPARA DE DUCHA
VIDRIO TEMPLADO 4 mm
VIDRIO TRANSPARENTE
CIERRE MAGNÉTICO
REVERSIBLE
ALTURA 185 cm

METALLIC
MÉTALLIQUE
METÁLICO

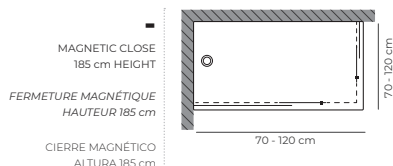

| MEASURES MESURES MEDIDAS | ADJUSTMENT AJUSTEMENT AJUSTAMIENTO | REF. | REF. |
|--------------------------------|--|-----------|-----------|
| 70 x 70 cm | 60 70 - 60 70 cm | DB0520401 | DB0520402 |
| 70 x 80 cm | 60 70 - 70 80 cm | DB0520431 | DB0520432 |
| 70 x 90 cm | 60 70 - 80 90 cm | DB0520436 | DB0520437 |
| 70 x 100 cm | 60 70 - 90 100 cm | DB0520441 | DB0520442 |
| 70 x 110 cm | 60 70 - 100 110 cm | DB0520446 | DB0520447 |
| 70 x 120 cm | 60 70 - 110 120 cm | DB0520451 | DB0520452 |
| 80 x 80 cm | 70 80 - 70 80 cm | DB0520406 | DB0520407 |
| 80 x 90 cm | 70 80 - 80 90 cm | DB0520456 | DB0520457 |
| 80 x 100 cm | 70 80 - 90 100 cm | DB0520461 | DB0520462 |
| 80 x 110 cm | 70 80 - 100 110 cm | DB0520466 | DB0520467 |
| 80 x 120 cm | 70 80 - 110 120 cm | DB0520471 | DB0520472 |
| 90 x 90 cm | 80 90 - 80 90 cm | DB0520411 | DB0520412 |
| 90 x 100 cm | 80 90 - 90 100 cm | DB0520476 | DB0520477 |
| 90 x 110 cm | 80 90 - 100 110 cm | DB0520481 | DB0520482 |
| 90 x 120 cm | 80 90 - 110 120 cm | DB0520486 | DB0520487 |
| 100 x 100 cm | 90 100 - 90 100 cm | DB0520416 | DB0520417 |
| 100 x 110 cm | 90 100 - 100 110 cm | DB0520491 | DB0520492 |
| 100 x 120 cm | 90 100 - 110 120 cm | DB0520496 | DB0520497 |
| 110 x 110 cm | 100 110 - 100 110 cm | DB0520421 | DB0520422 |
| 110 x 120 cm | 100 110 - 110 120 cm | DB0520501 | DB0520502 |
| 120 x 120 cm | 110 110 - 110 120 cm | DB0520426 | DB0520427 |

SPECIAL MEASURES ADD 25% TO THE PREVIOUS MEASURE PRICE
DES MESURES SPECIALES AJOUTENT 25% AU PRIX DE LA MESURE PRÉCÉDENTE
MEDIDAS ESPECIALES AUMENTAN UN 25% AL PRECIO DE LA MEDIDA ANTERIOR



FRONT SHOWER PANEL
W/ 2 DOORS
+ 2 FIXED PANELS
4 mm TEMPERED GLASS
TRANSPARENT GLASS
MAGNETIC CLOSE
185 cm HEIGHT

PORTE DE DOUCHE
A/2 PORTES
+ 2 PANNEAUX FIXES
VERRE TREMPÉ 4 mm
VERRE TRANSPARENT
FERMETURE MAGNÉTIQUE
HAUTEUR 185 cm

MAMPARA FRONTAL
DE DUCHA C/ 2 PUERTAS
+ 2 PANELES FIJOS
VIDRIO TEMPLADO 4 mm
VIDRIO TRANSPARENT
CIERRE MAGNÉTICO
ALTURA 185 cm

FRONT SHOWER PANEL
W/ 2 DOORS
+ 2 FIXED PANELS
4 mm TEMPERED GLASS
SERIGRAPHED GLASS
MAGNETIC CLOSE
185 cm HEIGHT

PORTE DE DOUCHE
A/2 PORTES
+ 2 PANNEAUX FIXES
VERRE TREMPÉ 4 mm
VERRE SÉRIGRAPHÉ
FERMETURE MAGNÉTIQUE
HAUTEUR 185 cm

MAMPARA FRONTAL
DE DUCHA C/ 2 PUERTAS
+ 2 PANELES FIJOS
VIDRIO TEMPLADO 4 mm
VIDRIO SERIGRAFADO
CIERRE MAGNÉTICO
ALTURA 185 cm



FRONT SHOWER PANEL
2 DOORS + 2 FIXED PANELS

PORTE DE DOUCHE
2 PORTES + 2 PANNEAUX FIXES

MAMPARA FRONTAL DE DUCHA
2 PUERTAS + 2 PANELES FIJOS

FRONT SHOWER PANEL
2 DOORS + 2 FIXED PANELS

PORTE DE DOUCHE
2 PORTES + 2 PANNEAUX FIXES

MAMPARA FRONTAL DE DUCHA
2 PUERTAS + 2 PANELES FIJOS

| MEASURES MESURES MEDIDAS | ADJUSTMENT AJUSTEMENT AJUSTAMIENTO | REF. | REF. |
|--------------------------------|--|-----------|-----------|
| 140 cm | 137 142 cm | DB0521501 | DB0521502 |
| 145 cm | 142 147 cm | DB0521506 | DB0521507 |
| 150 cm | 147 152 cm | DB0521511 | DB0521512 |
| 155 cm | 152 157 cm | DB0521516 | DB0521517 |
| 160 cm | 157 162 cm | DB0521521 | DB0521522 |
| 165 cm | 162 167 cm | DB0521526 | DB0521527 |
| 170 cm | 167 172 cm | DB0521531 | DB0521532 |
| 175 cm | 172 177 cm | DB0521536 | DB0521537 |
| 180 cm | 177 182 cm | DB0521541 | DB0521542 |
| 185 cm | 182 187 cm | DB0521546 | DB0521547 |
| 190 cm | 187 192 cm | DB0521551 | DB0521552 |
| 195 cm | 192 197 cm | DB0521556 | DB0521557 |
| 200 cm | 197 202 cm | DB0521561 | DB0521562 |

METALLIC
MÉTALLIQUE
METÁLICO

| MEASURES MESURES MEDIDAS | ADJUSTMENT AJUSTEMENT AJUSTAMIENTO | REF. | REF. |
|--------------------------------|--|-----------|-----------|
| 140 cm | 137 142 cm | DB0521001 | DB0521002 |
| 145 cm | 142 147 cm | DB0521006 | DB0521007 |
| 150 cm | 147 152 cm | DB0521011 | DB0521012 |
| 155 cm | 152 157 cm | DB0521016 | DB0521017 |
| 160 cm | 157 162 cm | DB0521021 | DB0521022 |
| 165 cm | 162 167 cm | DB0521026 | DB0521027 |
| 170 cm | 167 172 cm | DB0521031 | DB0521032 |
| 175 cm | 172 177 cm | DB0521036 | DB0521037 |
| 180 cm | 177 182 cm | DB0521041 | DB0521042 |
| 185 cm | 182 187 cm | DB0521046 | DB0521047 |
| 190 cm | 187 192 cm | DB0521051 | DB0521052 |
| 195 cm | 192 197 cm | DB0521056 | DB0521057 |
| 200 cm | 197 202 cm | DB0521061 | DB0521062 |

WHITE
BLANC
BLANCO

SIDE PANEL
PANNEAU LATÉRAL
PANEL LATERAL

| MEASURES MESURES MEDIDAS | ADJUSTMENT AJUSTEMENT AJUSTAMIENTO | REF. | REF. |
|--------------------------------|--|-----------|-----------|
| 70 cm | 67,5 72,5 cm | DB0521601 | DB0521602 |
| 75 cm | 72,5 77,5 cm | DB0521606 | DB0521607 |
| 80 cm | 77,5 82,5 cm | DB0521611 | DB0521612 |
| 90 cm | 87,5 92,5 cm | DB0521616 | DB0521617 |

METALLIC
MÉTALLIQUE
METÁLICO

SIDE PANEL
PANNEAU LATÉRAL
PANEL LATERAL

| MEASURES MESURES MEDIDAS | ADJUSTMENT AJUSTEMENT AJUSTAMIENTO | REF. | REF. |
|--------------------------------|--|-----------|-----------|
| 70 cm | 67,5 70 cm | DB0521101 | DB0521102 |
| 75 cm | 72,5 75 cm | DB0521106 | DB0521107 |
| 80 cm | 77,5 80 cm | DB0521111 | DB0521112 |
| 90 cm | 87,5 90 cm | DB0521116 | DB0521117 |

WHITE
BLANC
BLANCO

SPECIAL MEASURES ADD 25% TO THE PREVIOUS' MEASURE PRICE
DES MESURES SPECIALES AJOUTENT 25% AU PRIX DE LA MESURE PRÉCÉDENTE
MEDIDAS ESPECIALES AUMENTAN UN 25% AL PRECIO DE LA MEDIDA ANTERIOR

SPECIAL MEASURES ADD 25% TO THE PREVIOUS' MEASURE PRICE
DES MESURES SPECIALES AJOUTENT 25% AU PRIX DE LA MESURE PRÉCÉDENTE
MEDIDAS ESPECIALES AUMENTAN UN 25% AL PRECIO DE LA MEDIDA ANTERIOR



FRONT SHOWER PANEL
W/1 DOOR
+ 1 FIXE PANEL
4 mm TEMPERED GLASS
TRANSPARENT GLASS
MAGNETIC CLOSE
185 cm HEIGHT

PORTE DE DOUCHE
A/1 PORTE
+ 1 PANNEAU FIXE
VERRE TREMPÉ 4 mm
VERRE TRANSPARENT
FERMETURE MAGNÉTIQUE
HAUTEUR 185 cm

MAMPARA FRONTAL
DE DUCHA C/1 PUERTA
+ 1 PANEL FIJO
VIDRIO TEMPLADO 4 mm
VIDRIO TRANSPARENT
CIERRE MAGNÉTICO
ALTURA 185 cm

FRONT SHOWER PANEL
W/1 DOOR
+ 1 FIXE PANEL
4 mm TEMPERED GLASS
SERIGRAPHED GLASS
MAGNETIC CLOSE
185 cm HEIGHT

PORTE DE DOUCHE
A/1 PORTE
+ 1 PANNEAU FIXE
VERRE TREMPÉ 4 mm
VERRE SÉRIGRAPHIÉ
FERMETURE MAGNÉTIQUE
HAUTEUR 185 cm

MAMPARA FRONTAL
DE DUCHA C/1 PUERTA
+ 1 PANEL FIJO
VIDRIO TEMPLADO 4 mm
VIDRIO SERIGRAFADO
CIERRE MAGNÉTICO
ALTURA 185 cm



FRONT SHOWER PANEL 1 DOOR + 1 FIXE PANEL PORTE DE DOUCHE 1 PORTE + 1 PANNEAU FIXE MAMPARA FRONTAL DE DUCHA 1 PUERTA + 1 PANEL FIJO

| MEASURES MESURES MEDIDAS | ADJUSTMENT AJUSTEMENT AJUSTAMIENTO | REF. | REF. |
|--------------------------------|--|-----------|-----------|
| 90 cm | 87 92 cm | DB0523211 | DB0523212 |
| 95 cm | 92 97 cm | DB0523216 | DB0523217 |
| 100 cm | 97 102 cm | DB0523221 | DB0523222 |
| 105 cm | 102 107 cm | DB0523226 | DB0523227 |
| 110 cm | 107 112 cm | DB0523231 | DB0523232 |
| 115 cm | 112 117 cm | DB0523236 | DB0523237 |
| 120 cm | 117 122 cm | DB0523241 | DB0523242 |
| 125 cm | 122 127 cm | DB0523246 | DB0523247 |
| 130 cm | 127 132 cm | DB0523251 | DB0523252 |
| 135 cm | 132 137 cm | DB0523256 | DB0523257 |
| 140 cm | 137 142 cm | DB0523261 | DB0523262 |
| 145 cm | 142 147 cm | DB0523266 | DB0523267 |
| 150 cm | 147 152 cm | DB0523271 | DB0523272 |
| 155 cm | 152 157 cm | DB0523276 | DB0523277 |
| 160 cm | 157 162 cm | DB0523281 | DB0523282 |

METALLIC
MÉTALLIQUE
METÁLICO



FRONT SHOWER PANEL 1 DOOR + 1 FIXE PANEL PORTE DE DOUCHE 1 PORTE + 1 PANNEAU FIXE MAMPARA FRONTAL DE DUCHA 1 PUERTA + 1 PANEL FIJO

| MEASURES MESURES MEDIDAS | ADJUSTMENT AJUSTEMENT AJUSTAMIENTO | REF. | REF. |
|--------------------------------|--|-----------|-----------|
| 90 cm | 87 92 cm | DB0523011 | DB0523012 |
| 95 cm | 92 97 cm | DB0523016 | DB0523017 |
| 100 cm | 97 102 cm | DB0523021 | DB0523022 |
| 105 cm | 102 107 cm | DB0523026 | DB0523027 |
| 110 cm | 107 112 cm | DB0523031 | DB0523032 |
| 115 cm | 112 117 cm | DB0523036 | DB0523037 |
| 120 cm | 117 122 cm | DB0523041 | DB0523042 |
| 125 cm | 122 127 cm | DB0523046 | DB0523047 |
| 130 cm | 127 132 cm | DB0523051 | DB0523052 |
| 135 cm | 132 137 cm | DB0523056 | DB0523057 |
| 140 cm | 137 142 cm | DB0523061 | DB0523062 |
| 145 cm | 142 147 cm | DB0523066 | DB0523067 |
| 150 cm | 147 152 cm | DB0523071 | DB0523072 |
| 155 cm | 152 157 cm | DB0523076 | DB0523077 |
| 160 cm | 157 162 cm | DB0523081 | DB0523082 |

WHITE
BLANC
BLANCO

SIDE PANEL
PANNEAU LATÉRAL
PANEL LATERAL

| MEASURES MESURES MEDIDAS | ADJUSTMENT AJUSTEMENT AJUSTAMIENTO | REF. | REF. |
|--------------------------------|--|-----------|-----------|
| 70 cm | 67,5 72,5 cm | DB0521601 | DB0521602 |
| 75 cm | 72,5 77,5 cm | DB0521606 | DB0521607 |
| 80 cm | 77,5 82,5 cm | DB0521611 | DB0521612 |
| 90 cm | 87,5 92,5 cm | DB0521616 | DB0521617 |

METALLIC
MÉTALLIQUE
METÁLICO

SIDE PANEL
PANNEAU LATÉRAL
PANEL LATERAL

| MEASURES MESURES MEDIDAS | ADJUSTMENT AJUSTEMENT AJUSTAMIENTO | REF. | REF. |
|--------------------------------|--|-----------|-----------|
| 70 cm | 67,5 70 cm | DB0521101 | DB0521102 |
| 75 cm | 72,5 75 cm | DB0521106 | DB0521107 |
| 80 cm | 77,5 80 cm | DB0521111 | DB0521112 |
| 90 cm | 87,5 90 cm | DB0521116 | DB0521117 |

WHITE
BLANC
BLANCO

SPECIAL MEASURES ADD 25% TO THE PREVIOUS MEASURE PRICE
DES MESURES SPECIALES AJOUTENT 25% AU PRIX DE LA MESURE PRÉCÉDENTE
MEDIDAS ESPECIALES AUMENTAN UN 25% AL PRECIO DE LA MEDIDA ANTERIOR

SPECIAL MEASURES ADD 25% TO THE PREVIOUS MEASURE PRICE
DES MESURES SPECIALES AJOUTENT 25% AU PRIX DE LA MESURE PRÉCÉDENTE
MEDIDAS ESPECIALES AUMENTAN UN 25% AL PRECIO DE LA MEDIDA ANTERIOR



FRONT BATH PANEL
W/ 2 DOORS
+ 2 FIXED PANELS
4 mm TEMPERED GLASS
TRANSPARENT GLASS
MAGNETIC CLOSE
140 cm HEIGHT

PORTE DE BAIGNOIRE
A/2 PORTES
+ 2 PANNEAUX FIXES
VERRE TREMPÉ 4 mm
VERRE TRANSPARENT
FERMETURE MAGNÉTIQUE
HAUTEUR 140 cm

MAMPARA FRONTAL
DE BAÑO C/ 2 PUERTAS
+ 2 PANELES FIJOS
VIDRIO TEMPLADO 4 mm
VIDRIO TRANSPARENT
CIERRE MAGNÉTICO
ALTURA 140 cm

FRONT BATH PANEL
W/ 2 DOORS
+ 2 FIXED PANELS
4 mm TEMPERED GLASS
SERIGRAPHED GLASS
MAGNETIC CLOSE
140 cm HEIGHT

PORTE DE BAIGNOIRE
A/2 PORTES
+ 2 PANNEAUX FIXES
VERRE TREMPÉ 4 mm
VERRE SÉRIGRAPHÉ
FERMETURE MAGNÉTIQUE
HAUTEUR 140 cm

MAMPARA FRONTAL
DE BAÑO C/ 2 PUERTAS
+ 2 PANELES FIJOS
VIDRIO TEMPLADO 4 mm
VIDRIO SERIGRAFADO
CIERRE MAGNÉTICO
ALTURA 140 cm

140 cm HEIGHT
HAUTEUR 140 cm
ALTURA 140 cm

140 - 200 cm

FRONT BATH PANEL
2 DOORS + 2 FIXED PANELS

PORTE DE BAIGNOIRE
2 PORTES + 2 PANNEAUX FIXES

MAMPARA FRONTAL DE BAÑO
2 PUERTAS + 2 PANELES FIJOS

| MEASURES MESURES MEDIDAS | ADJUSTMENT AJUSTEMENT AJUSTAMIENTO | REF. | REF. |
|--------------------------------|--|-----------|-----------|
| 140 cm | 137 142 cm | DB0521701 | DB0521702 |
| 145 cm | 142 147 cm | DB0521706 | DB0521707 |
| 150 cm | 147 152 cm | DB0521711 | DB0521712 |
| 155 cm | 152 157 cm | DB0521716 | DB0521717 |
| 160 cm | 157 162 cm | DB0521721 | DB0521722 |
| 165 cm | 162 167 cm | DB0521726 | DB0521727 |
| 170 cm | 167 172 cm | DB0521731 | DB0521732 |
| 175 cm | 172 177 cm | DB0521736 | DB0521737 |
| 180 cm | 177 182 cm | DB0521741 | DB0521742 |
| 185 cm | 182 187 cm | DB0521746 | DB0521747 |
| 190 cm | 187 192 cm | DB0521751 | DB0521752 |
| 195 cm | 192 197 cm | DB0521756 | DB0521757 |
| 200 cm | 197 202 cm | DB0521761 | DB0521762 |

140 cm HEIGHT
HAUTEUR 140 cm
ALTURA 140 cm

140 - 200 cm

FRONT BATH PANEL
2 DOORS + 2 FIXED PANELS

PORTE DE BAIGNOIRE
2 PORTES + 2 PANNEAUX FIXES

MAMPARA FRONTAL DE BAÑO
2 PUERTAS + 2 PANELES FIJOS

| MEASURES MESURES MEDIDAS | ADJUSTMENT AJUSTEMENT AJUSTAMIENTO | REF. | REF. |
|--------------------------------|--|-----------|-----------|
| 140 cm | 137 142 cm | DB0521201 | DB0521202 |
| 145 cm | 142 147 cm | DB0521206 | DB0521207 |
| 150 cm | 147 152 cm | DB0521211 | DB0521212 |
| 155 cm | 152 157 cm | DB0521216 | DB0521217 |
| 160 cm | 157 162 cm | DB0521221 | DB0521222 |
| 165 cm | 162 167 cm | DB0521226 | DB0521227 |
| 170 cm | 167 172 cm | DB0521231 | DB0521232 |
| 175 cm | 172 177 cm | DB0521236 | DB0521237 |
| 180 cm | 177 182 cm | DB0521241 | DB0521242 |
| 185 cm | 182 187 cm | DB0521246 | DB0521247 |
| 190 cm | 187 192 cm | DB0521251 | DB0521252 |
| 195 cm | 192 197 cm | DB0521256 | DB0521257 |
| 200 cm | 197 202 cm | DB0521261 | DB0521262 |

SIDE PANEL
PANNEAU LATÉRAL
PANEL LATERAL

70 - 80 cm

FRONT BATH PANEL
2 DOORS + 2 FIXED PANELS

PORTE DE BAIGNOIRE
2 PORTES + 2 PANNEAUX FIXES

MAMPARA FRONTAL DE BAÑO
2 PUERTAS + 2 PANELES FIJOS

| MEASURES MESURES MEDIDAS | ADJUSTMENT AJUSTEMENT AJUSTAMIENTO | REF. | REF. |
|--------------------------------|--|-----------|-----------|
| 70 cm | 67,5 72,5 cm | DB0521801 | DB0521802 |
| 75 cm | 72,5 77,5 cm | DB0521806 | DB0521807 |
| 80 cm | 77,5 82,5 cm | DB0521811 | DB0521812 |

SIDE PANEL
PANNEAU LATÉRAL
PANEL LATERAL

70 - 80 cm

FRONT BATH PANEL
2 DOORS + 2 FIXED PANELS

PORTE DE BAIGNOIRE
2 PORTES + 2 PANNEAUX FIXES

MAMPARA FRONTAL DE BAÑO
2 PUERTAS + 2 PANELES FIJOS

| MEASURES MESURES MEDIDAS | ADJUSTMENT AJUSTEMENT AJUSTAMIENTO | REF. | REF. |
|--------------------------------|--|-----------|-----------|
| 70 cm | 67,5 72,5 cm | DB0521301 | DB0521302 |
| 75 cm | 72,5 77,5 cm | DB0521306 | DB0521307 |
| 80 cm | 77,5 82,5 cm | DB0521311 | DB0521312 |

SPECIAL MEASURES ADD 25% TO THE PREVIOUS MEASURE PRICE
DES MESURES SPECIALES AJOUTENT 25% AU PRIX DE LA MESURE PRÉCÉDENTE
MEDIDAS ESPECIALES AUMENTAN UN 25% AL PRECIO DE LA MEDIDA ANTERIOR

SPECIAL MEASURES ADD 25% TO THE PREVIOUS MEASURE PRICE
DES MESURES SPECIALES AJOUTENT 25% AU PRIX DE LA MESURE PRÉCÉDENTE
MEDIDAS ESPECIALES AUMENTAN UN 25% AL PRECIO DE LA MEDIDA ANTERIOR



FRONT BATH PANEL
W/1 DOOR
+ 1 FIXE PANEL
4 mm TEMPERED GLASS
SERIGRAPHED GLASS
MAGNETIC CLOSE
140 cm HEIGHT

PORTE DE BAINOIRE
A/1 PORTE
+ 1 PANNEAU FIXE
VERRE TREMPÉ 4 mm
VERRE SÉRIGRAPHIÉ
FERMETURE MAGNÉTIQUE
HAUTEUR 140 cm

MAMPARA FRONTAL
DE BAÑO C/1 PUERTA
+ 1 PANEL FIJO
VIDRIO TEMPLADO 4 mm
VIDRIO SERIGRAFADO
CIERRE MAGNÉTICO
ALTURA 140 cm



FRONT BATH PANEL
W/1 DOOR
+ 1 FIXE PANEL
4 mm TEMPERED GLASS
TRANSPARENT GLASS
MAGNETIC CLOSE
140 cm HEIGHT

PORTE DE BAINOIRE
A/1 PORTE
+ 1 PANNEAU FIXE
VERRE TREMPÉ 4 mm
VERRE TRANSPARENT
FERMETURE MAGNÉTIQUE
HAUTEUR 140 cm

MAMPARA FRONTAL
DE BAÑO C/1 PUERTA
+ 1 PANEL FIJO
VIDRIO TEMPLADO 4 mm
VIDRIO TRANSPARENT
CIERRE MAGNÉTICO
ALTURA 140 cm

140 cm HEIGHT
HAUTEUR 140 cm
ALTURA 140 cm

140 - 200 cm

FRONT BATH PANEL 1 DOORS + 1 FIXED PANEL
PORTE DE BAINOIRE 1 PORTE + 1 PANNEAU FIXE
MAMPARA FRONTAL DE BAÑO 1 PUERTA + 1 PANEL FIJO

| MEASURES MESURES MEDIDAS | ADJUSTMENT AJUSTEMENT AJUSTAMIENTO | REF. | REF. |
|--------------------------------|--|-----------|-----------|
| 140 cm | 137 142 cm | DB0523701 | DB0523702 |
| 145 cm | 142 147 cm | DB0523706 | DB0523707 |
| 150 cm | 147 152 cm | DB0523711 | DB0523712 |
| 155 cm | 152 157 cm | DB0523716 | DB0523717 |
| 160 cm | 157 162 cm | DB0523721 | DB0523722 |
| 165 cm | 162 167 cm | DB0523726 | DB0523727 |
| 170 cm | 167 172 cm | DB0523731 | DB0523732 |
| 175 cm | 172 177 cm | DB0523736 | DB0523737 |
| 180 cm | 177 182 cm | DB0523741 | DB0523742 |
| 185 cm | 182 187 cm | DB0523746 | DB0523747 |
| 190 cm | 187 192 cm | DB0523751 | DB0523752 |
| 195 cm | 192 197 cm | DB0523756 | DB0523757 |
| 200 cm | 197 202 cm | DB0523761 | DB0523762 |

METALLIC
MÉTALLIQUE
METÁLICO

140 cm HEIGHT
HAUTEUR 140 cm
ALTURA 140 cm

140 - 200 cm

FRONT BATH PANEL 1 DOORS + 1 FIXED PANEL
PORTE DE BAINOIRE 1 PORTE + 1 PANNEAU FIXE
MAMPARA FRONTAL DE BAÑO 1 PUERTA + 1 PANEL FIJO

| MEASURES MESURES MEDIDAS | ADJUSTMENT AJUSTEMENT AJUSTAMIENTO | REF. | REF. |
|--------------------------------|--|-----------|-----------|
| 140 cm | 137 142 cm | DB0523501 | DB0523502 |
| 145 cm | 142 147 cm | DB0523506 | DB0523507 |
| 150 cm | 147 152 cm | DB0523511 | DB0523512 |
| 155 cm | 152 157 cm | DB0523516 | DB0523517 |
| 160 cm | 157 162 cm | DB0523521 | DB0523522 |
| 165 cm | 162 167 cm | DB0523526 | DB0523527 |
| 170 cm | 167 172 cm | DB0523531 | DB0523532 |
| 175 cm | 172 177 cm | DB0523536 | DB0523537 |
| 180 cm | 177 182 cm | DB0523541 | DB0523542 |
| 185 cm | 182 187 cm | DB0523546 | DB0523547 |
| 190 cm | 187 192 cm | DB0523551 | DB0523552 |
| 195 cm | 192 197 cm | DB0523556 | DB0523557 |
| 200 cm | 197 202 cm | DB0523561 | DB0523562 |

WHITE
BLANC
BLANCO

SIDE PANEL
PANNEAU LATÉRAL
PANEL LATERAL

70 - 80 cm

FRONT BATH PANEL 1 DOORS + 1 FIXED PANEL
PORTE DE BAINOIRE 1 PORTE + 1 PANNEAU FIXE
MAMPARA FRONTAL DE BAÑO 1 PUERTA + 1 PANEL FIJO

| MEASURES MESURES MEDIDAS | ADJUSTMENT AJUSTEMENT AJUSTAMIENTO | REF. | REF. |
|--------------------------------|--|-----------|-----------|
| 70 cm | 67,5 72,5 cm | DB0521801 | DB0521802 |
| 75 cm | 72,5 77,5 cm | DB0521806 | DB0521807 |
| 80 cm | 77,5 82,5 cm | DB0521811 | DB0521812 |

METALLIC
MÉTALLIQUE
METÁLICO

SIDE PANEL
PANNEAU LATÉRAL
PANEL LATERAL

70 - 80 cm

FRONT BATH PANEL 1 DOORS + 1 FIXED PANEL
PORTE DE BAINOIRE 1 PORTE + 1 PANNEAU FIXE
MAMPARA FRONTAL DE BAÑO 1 PUERTA + 1 PANEL FIJO

| MEASURES MESURES MEDIDAS | ADJUSTMENT AJUSTEMENT AJUSTAMIENTO | REF. | REF. |
|--------------------------------|--|-----------|-----------|
| 70 cm | 67,5 72,5 cm | DB0521301 | DB0521302 |
| 75 cm | 72,5 77,5 cm | DB0521306 | DB0521307 |
| 80 cm | 77,5 82,5 cm | DB0521311 | DB0521312 |

WHITE
BLANC
BLANCO

SPECIAL MEASURES ADD 25% TO THE PREVIOUS MEASURE PRICE
DES MESURES SPECIALES AJOUTENT 25% AU PRIX DE LA MESURE PRÉCÉDENTE
MEDIDAS ESPECIALES AUMENTAN UN 25% AL PRECIO DE LA MEDIDA ANTERIOR

SPECIAL MEASURES ADD 25% TO THE PREVIOUS MEASURE PRICE
DES MESURES SPECIALES AJOUTENT 25% AU PRIX DE LA MESURE PRÉCÉDENTE
MEDIDAS ESPECIALES AUMENTAN UN 25% AL PRECIO DE LA MEDIDA ANTERIOR



FRONT SHOWER PANEL
W/ 2 DOORS + 1 FIXED
PANEL + 1 SIDE PANEL
WHITE PROFILE
ACRYLIC PANELS
MAGNETIC CLOSE
REVERSIBLE
185 cm HEIGHT

PORTE DE DOUCHE
A/ 2 PORTES + 1 PANNEAU
FIXE + 1 PANNEAU LATÉRAL
PROFIL BLANC
PANNEAUX EN ACRYLIQUE
FERMETURE MAGNÉTIQUE
RÉVERSIBLE
HAUTEUR 185 cm

MAMPARA FRONTAL DE DUCHA
C/ 2 PUERTAS + 1 PANEL FIJO
+ 1 PANEL LATERAL
PERFIL BLANCO
PANELES DE ACRÍLICO
CIERRE MAGNÉTICO
REVERSIBLE
ALTURA 185 cm

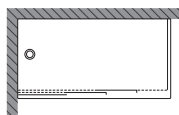

80 - 200 cm

ACRYLIC PANELS
185 cm HEIGHT
PANNEAUX EN ACRYLIQUE
HAUTEUR 185 cm
PANELES DE ACRÍLICO
ALTURA 185 cm

FRONT SHOWER PANEL
2 DOORS + 1 FIXE PANEL

PORTE DE DOUCHE
2 PORTES + 1 PANNEAU FIXE

MAMPARA FRONTAL DE DUCHA
2 PUERTAS + 1 PANEL FIJO

| MEASURES MESURES MEDIDAS | ADJUSTMENT AJUSTEMENT AJUSTAMIENTO | REF. |
|--------------------------------|--|-----------|
| 80 cm | 77 82 cm | DB0524000 |
| 85 cm | 82 87 cm | DB0524005 |
| 90 cm | 87 92 cm | DB0524010 |
| 95 cm | 92 97 cm | DB0524015 |
| 100 cm | 97 102 cm | DB0524020 |
| 105 cm | 102 107 cm | DB0524025 |
| 110 cm | 107 112 cm | DB0524030 |
| 115 cm | 112 117 cm | DB0524035 |
| 120 cm | 117 122 cm | DB0524040 |
| 125 cm | 122 127 cm | DB0524045 |
| 130 cm | 127 132 cm | DB0524050 |
| 135 cm | 132 137 cm | DB0524055 |
| 140 cm | 137 142 cm | DB0524060 |
| 145 cm | 142 147 cm | DB0524065 |
| 150 cm | 147 152 cm | DB0524070 |
| 155 cm | 152 157 cm | DB0524075 |
| 160 cm | 157 162 cm | DB0524080 |
| 165 cm | 162 167 cm | DB0524085 |
| 170 cm | 167 172 cm | DB0524090 |
| 175 cm | 172 177 cm | DB0524095 |
| 180 cm | 177 182 cm | DB0524100 |
| 185 cm | 182 187 cm | DB0524105 |
| 190 cm | 187 192 cm | DB0524110 |
| 195 cm | 192 197 cm | DB0524115 |
| 200 cm | 197 202 cm | DB0524120 |

WHITE
BLANC
BLANCO

SIDE PANEL
PANNEAU LATÉRAL
PANEL LATERAL

| MEASURES MESURES MEDIDAS | ADJUSTMENT AJUSTEMENT AJUSTAMIENTO | REF. |
|--------------------------------|--|-----------|
| 70 cm | 67,5 70 cm | DB0524500 |
| 75 cm | 72,5 75 cm | DB0524505 |
| 80 cm | 77,5 80 cm | DB0524510 |
| 90 cm | 87,5 90 cm | DB0524515 |

WHITE
BLANC
BLANCO

SPECIAL MEASURES ADD 25% TO THE PREVIOUS' MEASURE PRICE
DES MESURES SPECIALES AJOUTENT 25% AU PRIX DE LA MESURE PRÉCÉDENTE
MEDIDAS ESPECIALES AJUNTAN UN 25% AL PRECIO DE LA MEDIDA ANTERIOR



FRONT BATH PANEL
W/ 2 DOORS + 1 FIXED
PANEL + 1 SIDE PANEL
WHITE PROFILE
ACRYLIC PANELS
MAGNETIC CLOSE
REVERSIBLE
140 cm HEIGHT

PORTE DE BAIGNOIRE
A/ 2 PORTES + 1 PANNEAU
FIXE + 1 PANNEAU LATÉRAL
PROFIL BLANC
PANNEAUX EN ACRYLIQUE
FERMETURE MAGNÉTIQUE
RÉVERSIBLE
HAUTEUR 140 cm

MAMPARA FRONTAL DE BAÑO
C/ 2 PUERTAS + 1 PANEL FIJO
+ 1 PANEL LATERAL
PERFIL BLANCO
PANELES DE ACRÍLICO
CIERRE MAGNÉTICO
REVERSIBLE
ALTURA 140 cm

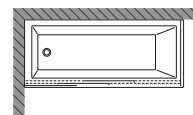

150 - 200 cm

70 - 80 cm

ACRYLIC PANELS
140 cm HEIGHT
PANNEAUX EN ACRYLIQUE
HAUTEUR 140 cm
PANELES DE ACRÍLICO
ALTURA 140 cm

FRONT BATH PANEL
2 DOORS + 1 FIXE PANEL

PORTE DE BAIGNOIRE
2 PORTES + 1 PANNEAU FIXE

MAMPARA FRONTAL DE DUCHA
2 PUERTAS + 1 PANEL FIJO

| MEASURES MESURES MEDIDAS | ADJUSTMENT AJUSTEMENT AJUSTAMIENTO | REF. |
|--------------------------------|--|-----------|
| 150 cm | 147 152 cm | DB0525000 |
| 155 cm | 152 157 cm | DB0525005 |
| 160 cm | 157 162 cm | DB0525010 |
| 165 cm | 162 167 cm | DB0525015 |
| 170 cm | 167 172 cm | DB0525020 |
| 175 cm | 172 177 cm | DB0525025 |
| 180 cm | 177 182 cm | DB0525030 |
| 185 cm | 182 187 cm | DB0525035 |
| 190 cm | 187 192 cm | DB0525040 |
| 195 cm | 192 197 cm | DB0525045 |
| 200 cm | 197 202 cm | DB0525050 |

WHITE
BLANC
BLANCO

SIDE PANEL
PANNEAU LATÉRAL
PANEL LATERAL

| MEASURES MESURES MEDIDAS | ADJUSTMENT AJUSTEMENT AJUSTAMIENTO | REF. |
|--------------------------------|--|-----------|
| 70 cm | 67,5 70 cm | DB0525500 |
| 75 cm | 72,5 75 cm | DB0525505 |
| 80 cm | 77,5 80 cm | DB0525510 |

WHITE
BLANC
BLANCO

SPECIAL MEASURES ADD 25% TO THE PREVIOUS' MEASURE PRICE
DES MESURES SPECIALES AJOUTENT 25% AU PRIX DE LA MESURE PRÉCÉDENTE
MEDIDAS ESPECIALES AJUNTAN UN 25% AL PRECIO DE LA MEDIDA ANTERIOR



■ ACRYLIC PANELS
185 cm HEIGHT

PANNEAUX EN ACRYLIQUE
HAUTEUR 185 cm

PANELES DE ACRÍLICO
ALTURA 185 cm

SHOWER ENCLOSURE
CABINE DE DOUCHE
MAMPARA DE DUCHA

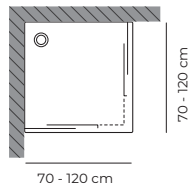

SHOWER ENCLOSURE
W/ 2 DOORS
+ 2 FIXED PANELS
WHITE PROFILE
ACRYLIC PANELS
MAGNETIC CLOSE
REVERSIBLE
185 cm HEIGHT

CABINE DE DOUCHE
A/ 2 PORTES
+ 2 PANNEAUX FIXES
PROFIL BLANC
PANNEAUX EN ACRYLIQUE
FERMETURE MAGNÉTIQUE
RÉVERSIBLE
HAUTEUR 185 cm

MAMPARA DE DUCHA
C/ 2 PUERTAS
+ 2 PANELES FIJOS
PERFIL BLANCO
PANELES DE ACRÍLICO
CIERRE MAGNÉTICO
REVERSIBLE
ALTURA 185 cm

| MEASURES MESURES MEDIDAS | ADJUSTMENT AJUSTEMENT AJUSTAMIENTO | REF. |
|--------------------------------|--|-----------|
| 70 x 70 cm | 60 70 cm | DB0520000 |
| 70 x 80 cm | 60 70 - 70 80 cm | DB0520030 |
| 70 x 90 cm | 60 70 - 80 90 cm | DB0520035 |
| 70 x 100 cm | 60 70 - 90 100 cm | DB0520040 |
| 70 x 110 cm | 60 70 - 100 110 cm | DB0520045 |
| 70 x 120 cm | 60 70 - 110 120 cm | DB0520050 |
| 80 x 80 cm | 70 80 cm | DB0520005 |
| 80 x 90 cm | 70 80 - 80 90 cm | DB0520055 |
| 80 x 100 cm | 70 80 - 90 100 cm | DB0520060 |
| 80 x 110 cm | 70 80 - 100 110 cm | DB0520065 |
| 80 x 120 cm | 70 80 - 110 120 cm | DB0520070 |

○ WHITE
BLANC
BLANCO

| MEASURES MESURES MEDIDAS | ADJUSTMENT AJUSTEMENT AJUSTAMIENTO | REF. |
|--------------------------------|--|-----------|
| 90 x 90 cm | 80 90 cm | DB0520010 |
| 90 x 100 cm | 80 90 - 90 100 cm | DB0520075 |
| 90 x 110 cm | 80 90 - 100 110 cm | DB0520080 |
| 90 x 120 cm | 80 90 - 110 120 cm | DB0520085 |
| 100 x 100 cm | 90 100 cm | DB0520015 |
| 100 x 110 cm | 90 100 - 100 110 cm | DB0520090 |
| 100 x 120 cm | 90 100 - 110 120 cm | DB0520095 |
| 110 x 110 cm | 100 110 cm | DB0520020 |
| 110 x 120 cm | 100 110 - 110 120 cm | DB0520100 |
| 120 x 120 cm | 110 120 cm | DB0520025 |

SPECIAL MEASURES ADD 25% TO THE PREVIOUS' MEASURE PRICE
DES MESURES SPECIALES AJOUTENT 25% AU PRIX DE LA MESURE PRÉCÉDENTE
MEDIDAS ESPECIALES AUMENTAN UN 25% AL PRECIO DE LA MEDIDA ANTERIOR



FRONT SHOWER PANEL
W/ 2 DOORS
+ 2 FIXED PANELS
WHITE PROFILE
ACRYLIC PANELS
MAGNETIC CLOSE
REVERSIBLE
185 cm HEIGHT

PORTE DE DOUCHE
A/ 2 PORTES
+ 2 PANNEAUX FIXES
PROFIL BLANC
PANNEAUX EN ACRYLIQUE
FERMETURE MAGNÉTIQUE
RÉVERSIBLE
HAUTEUR 185 cm

MAMPARA FRONTAL DE
DUCHA C/ 2 PUERTAS
+ 2 PANELES FIJOS
PERFIL BLANC
PANELES DE ACRÍLICO
CIERRE MAGNÉTICO
REVERSIBLE
ALTURA 185 cm

FRONT SHOWER PANEL
W/ 1 DOOR
+ 1 FIXED PANEL
WHITE PROFILE
ACRYLIC PANELS
MAGNETIC CLOSE
REVERSIBLE
185 cm HEIGHT

PORTE DE DOUCHE
A/ 1 PORTE
+ 1 PANNEAU FIXE
PROFIL BLANC
PANNEAUX EN ACRYLIQUE
FERMETURE MAGNÉTIQUE
RÉVERSIBLE
HAUTEUR 185 cm

MAMPARA FRONTAL DE
DUCHA C/ 1 PUERTA
+ 1 PANEL FIJO
PERFIL BLANC
PANELES DE ACRÍLICO
CIERRE MAGNÉTICO
REVERSIBLE
ALTURA 185 cm

ACRYLIC PANELS
185 cm HEIGHT

PANNEAUX EN ACRYLIQUE
HAUTEUR 185 cm

PANELES DE ACRÍLICO
ALTURA 185 cm

140 - 200 cm

FRONT SHOWER PANEL
2 DOORS + 2 FIXED PANELS

PORTE DE DOUCHE
2 PORTES + 2 PANNEAUX FIXES

MAMPARA FRONTAL DE DUCHA
2 PUERTAS + 2 PANELES FIJOS

ACRYLIC PANELS
185 cm HEIGHT

PANNEAUX EN ACRYLIQUE
HAUTEUR 185 cm

PANELES DE ACRÍLICO
ALTURA 185 cm

90 - 180 cm

FRONT SHOWER PANEL
1 DOOR + 1 FIXED PANEL

PORTE DE DOUCHE
1 PORTE + 1 PANNEAU FIXE

MAMPARA FRONTAL DE DUCHA
1 PUERTA + 1 PANEL FIJO

| MEASURES MESURES MEDIDAS | ADJUSTMENT AJUSTEMENT AJUSTAMIENTO | REF. |
|--------------------------------|--|-----------|
| 140 cm | 137 142 cm | DB0521000 |
| 145 cm | 142 147 cm | DB0521005 |
| 150 cm | 147 152 cm | DB0521010 |
| 155 cm | 152 157 cm | DB0521015 |
| 160 cm | 157 162 cm | DB0521020 |
| 165 cm | 162 167 cm | DB0521025 |
| 170 cm | 167 172 cm | DB0521030 |
| 175 cm | 172 177 cm | DB0521035 |
| 180 cm | 177 182 cm | DB0521040 |
| 185 cm | 182 187 cm | DB0521045 |
| 190 cm | 187 192 cm | DB0521050 |
| 195 cm | 192 197 cm | DB0521055 |
| 200 cm | 197 202 cm | DB0521060 |

WHITE
BLANC
BLANCO

| MEASURES MESURES MEDIDAS | ADJUSTMENT AJUSTEMENT AJUSTAMIENTO | REF. |
|--------------------------------|--|-----------|
| 90 cm | 87 92 cm | DB0523010 |
| 95 cm | 92 97 cm | DB0523015 |
| 100 cm | 97 102 cm | DB0523020 |
| 105 cm | 102 107 cm | DB0523025 |
| 110 cm | 107 112 cm | DB0523030 |
| 115 cm | 112 117 cm | DB0523035 |
| 120 cm | 117 122 cm | DB0523040 |
| 125 cm | 122 127 cm | DB0523045 |
| 130 cm | 127 132 cm | DB0523050 |
| 135 cm | 132 137 cm | DB0523055 |
| 140 cm | 137 142 cm | DB0523060 |
| 145 cm | 142 147 cm | DB0523065 |
| 150 cm | 147 152 cm | DB0523070 |
| 155 cm | 152 157 cm | DB0523075 |
| 160 cm | 157 162 cm | DB0523080 |
| 165 cm | 162 167 cm | DB0523085 |
| 170 cm | 167 172 cm | DB0523090 |
| 175 cm | 172 177 cm | DB0523095 |
| 180 cm | 177 182 cm | DB0523100 |

WHITE
BLANC
BLANCO

SIDE PANEL
PANNEAU LATÉRAL
PANEL LATERAL

| MEASURES MESURES MEDIDAS | ADJUSTMENT AJUSTEMENT AJUSTAMIENTO | REF. |
|--------------------------------|--|-----------|
| 70 cm | 67,5 70 cm | DB0521100 |
| 75 cm | 72,5 75 cm | DB0521105 |
| 80 cm | 77,5 80 cm | DB0521110 |
| 90 cm | 87,5 90 cm | DB0521115 |

WHITE
BLANC
BLANCO

SPECIAL MEASURES ADD 25% TO THE PREVIOUS' MEASURE PRICE
DES MESURES SPECIALES AJOUTENT 25% AU PRIX DE LA MESURE PRÉCÉDENTE
MEDIDAS ESPECIALES AJUMENTAN UN 25% AL PRECIO DE LA MEDIDA ANTERIOR



FRONT BATH PANEL
W/ 2 DOORS
+ 2 FIXED PANELS
WHITE PROFILE
ACRYLIC PANELS
MAGNETIC CLOSE
REVERSIBLE
140 cm HEIGHT

PORTE DE BAIGNOIRE
A/ 2 PORTES
+ 2 PANNEAUX FIXES
PROFIL BLANC
PANNEAUX EN ACRYLIQUE
FERMETURE MAGNÉTIQUE
RÉVERSIBLE
HAUTEUR 140 cm

MAMPARA FRONTAL DE
BAÑO C/ 2 PUERTAS
+ 2 PANELES FIJOS
PERFIL BLANCO
PANELES DE ACRÍLICO
CIERRE MAGNÉTICO
REVERSIBLE
ALTURA 140 cm



| MEASURES MESURES MEDIDAS | ADJUSTMENT AJUSTEMENT AJUSTAMIENTO | REF. |
|--------------------------------|--|-----------|
| 140 cm | 137 142 cm | DB0521200 |
| 145 cm | 142 147 cm | DB0521205 |
| 150 cm | 147 152 cm | DB0521210 |
| 155 cm | 152 157 cm | DB0521215 |
| 160 cm | 157 162 cm | DB0521220 |
| 165 cm | 162 167 cm | DB0521225 |
| 170 cm | 167 172 cm | DB0521230 |
| 175 cm | 172 177 cm | DB0521235 |
| 180 cm | 177 182 cm | DB0521240 |
| 185 cm | 182 187 cm | DB0521245 |
| 190 cm | 187 192 cm | DB0521250 |
| 195 cm | 192 197 cm | DB0521255 |
| 200 cm | 197 202 cm | DB0521260 |

WHITE
BLANC
BLANCO

SIDE PANEL
PANNEAU LATÉRAL
PANEL LATERAL

| MEASURES MESURES MEDIDAS | ADJUSTMENT AJUSTEMENT AJUSTAMIENTO | REF. |
|--------------------------------|--|-----------|
| 70 cm | 67,5 70 cm | DB0521300 |
| 75 cm | 72,5 75 cm | DB0521305 |
| 80 cm | 77,5 80 cm | DB0521310 |

WHITE
BLANC
BLANCO

SPECIAL MEASURES ADD 25% TO THE PREVIOUS' MEASURE PRICE
DES MESURES SPECIALES AJOUTENT 25% AU PRIX DE LA MESURE PRÉCÉDENTE
MEDIDAS ESPECIALES AUMENTAN UN 25% AL PRECIO DE LA MEDIDA ANTERIOR



FRONT BATH PANEL
W/ 1 DOOR
+ 1 FIXED PANEL
WHITE PROFILE
ACRYLIC PANELS
MAGNETIC CLOSE
REVERSIBLE
140 cm HEIGHT

PORTE DE BAIGNOIRE
A/ 1 PORTE
+ 1 PANNEAU FIXE
PROFIL BLANC
PANNEAUX EN ACRYLIQUE
FERMETURE MAGNÉTIQUE
RÉVERSIBLE
HAUTEUR 140 cm

MAMPARA FRONTAL DE
BAÑO C/ 1 PUERTA
+ 1 PANEL FIJO
PERFIL BLANCO
PANELES DE ACRÍLICO
CIERRE MAGNÉTICO
REVERSIBLE
ALTURA 140 cm



| MEASURES MESURES MEDIDAS | ADJUSTMENT AJUSTEMENT AJUSTAMIENTO | REF. |
|--------------------------------|--|-----------|
| 140 cm | 137 142 cm | DB0523500 |
| 145 cm | 142 147 cm | DB0523505 |
| 150 cm | 147 152 cm | DB0523510 |
| 155 cm | 152 157 cm | DB0523515 |
| 160 cm | 157 162 cm | DB0523520 |
| 165 cm | 162 167 cm | DB0523525 |
| 170 cm | 167 172 cm | DB0523530 |
| 175 cm | 172 177 cm | DB0523535 |
| 180 cm | 177 182 cm | DB0523540 |
| 185 cm | 182 187 cm | DB0523545 |
| 190 cm | 187 192 cm | DB0523550 |
| 195 cm | 192 197 cm | DB0523555 |
| 200 cm | 197 202 cm | DB0523560 |

WHITE
BLANC
BLANCO

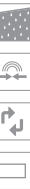



shower trays receveurs de douche platos de ducha

A shower tray takes up less space than a bathtub. In case you match it with a shower cabin, you will have a more spacious and attractive bathroom. You will get a perfect water flow by using Ctesi shower trays and drain valves. They all come in different shapes, sizes and materials so you can easily adapt them to your bathroom.

Un receveur de douche prend moins de place qu'une baignoire. Si vous le combinez avec une cabine de douche, vous disposerez d'une salle de bains plus spacieuse et plus attrayante. Vous obtiendrez un débit d'eau parfait en utilisant les receveurs de douche et les vannes de drainage Ctesi. Ils sont tous disponibles dans différentes formes, tailles et matériaux afin que vous puissiez facilement les adapter à votre salle de bains.

Un plato de ducha ocupa mucho menos espacio y, cuando lo combinas con una mampara de ducha, haces que tu baño sea más espacioso y atractivo. Al utilizar los platos de ducha y las válvulas de drenaje Ctesi, obtendrás el flujo perfecto de agua. Todos tienen diferentes formas, tamaños y materiales para que puedas adaptarlos fácilmente a tu baño.



+

INCLUDES
SHOWER VALVE
VIDAGE DE
DOUCHE INCLUS
INCLUYE VÁLVULA
DE DUCHA



SHOWER VALVE
VIDAGE DE DOUCHE
VÁLVULA DE DUCHA

PETRA

INNOVATIVE SYSTEM
SISTÈME INNOVANT
SISTEMA INNOVADOR

HIGH DRAINAGE FLOW
DÉBIT DE DRAINAGE ÉLEVÉ
ALTO FLUJO DE DRENAJE

Water flow rate highly above the criteria required by the EN-274 Standard (<24L / min)

Débit supérieure aux critères exigés dans la norme européenne EN-274 (<24L / min)

Velocidad del flujo superior a los criterios exigidos por la normativa europea EN-274 (<24L / min)

| B 70/80 | | | B 90/100 | | | B 120 | | |
|---------|---------|-----|----------|---------|-----|-------|---------|-----|
| A | C | D | A | C | D | A | C | D |
| 80 | 30 | 2.5 | 90x90 | 30 | 2.5 | 120 | Central | 3.0 |
| 80x80 | Central | 2.5 | 100x90 | Central | 2.5 | 160 | Central | 3.0 |
| 90 | 30 | 2.5 | 100x100 | 30 | 2.5 | 220 | Central | 3.0 |
| 100 | 30 | 2.5 | 120 | 30 | 2.5 | | | |
| 110 | 30 | 2.5 | 140 | 30 | 2.5 | | | |
| 120 | 35 | 2.5 | 150 | 35 | 2.5 | | | |
| 130 | 35 | 2.7 | 160 | 35 | 2.7 | | | |
| 140 | 40 | 2.7 | 170 | 40 | 2.7 | | | |
| 150 | 40 | 2.9 | 180 | 40 | 2.9 | | | |
| 160 | 45 | 2.9 | 190 | 45 | 2.9 | | | |
| 170 | 45 | 2.9 | 200 | 45 | 2.9 | | | |
| 180 | 50 | 2.9 | 220 | 50 | 2.9 | | | |
| 190 | 50 | 3.0 | 240x100 | 50 | 3.0 | | | |
| 200 | 50 | 3.0 | | | | | | |
| 220 | Central | 3.0 | | | | | | |

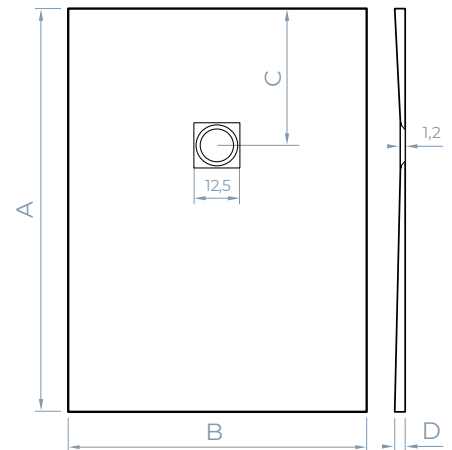

EXTRA FLAT MINERAL FILLER SHOWER TRAYS

RECEVEURS DE DOUCHE EXTRA PLATS DE CHARGES MINÉRALES

PLATOS DE DUCHA EXTRAPLANOS DE CARGAS MINERALES

Stone shower trays have an extra flat surface and a minimum height, allowing an easy and safe access for the entire family. They have a anti-slip finish that excels in comfort and brings back the feeling of a natural stone.

Les receveurs de douche Stone ont une surface extra plate et une hauteur minimale, ce qui permet un accès facile et sûr pour toute la famille. Ils ont une finition antidérapante qui vise un confort total et qui rappelle la sensation de la pierre.

Los platos de ducha Stone tienen una superficie extraplana y una altura mínima, lo que permite un acceso fácil y seguro para toda la familia. Tienen un acabado antideslizante que busca la máxima comodidad y que recuerda la sensación de la piedra.

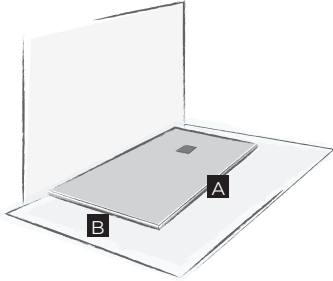

MEASURES IN cm
MESURES EN cm
MEDIDAS EN cm

| | | A | | | | | | | | | | | | | | | |
|---|---|-----|-----------|-----------|-----------|-----------|-----------|-----------|-----------|-----------|-----------|-----------|-----------|-----------|-----------|-----------|-----------|
| | | 80 | 90 | 100 | 110 | 120 | 130 | 140 | 150 | 160 | 170 | 180 | 190 | 200 | 220 | 240 | |
| RAL® 9003 WHITE BLANC BLANCO | B | 70 | - | DB1550010 | DB1550015 | DB1550020 | DB1550025 | DB1550030 | DB1550035 | DB1550040 | DB1550045 | DB1550050 | DB1550055 | DB1550060 | DB1550065 | DB1550075 | - |
| | | 80 | DB1550200 | DB1550210 | DB1550215 | DB1550220 | DB1550225 | DB1550230 | DB1550235 | DB1550240 | DB1550245 | DB1550250 | DB1550255 | DB1550260 | DB1550265 | DB1550275 | DB1550285 |
| | | 90 | - | DB1550400 | DB1550410 | DB1550415 | DB1550420 | DB1550425 | DB1550430 | DB1550435 | DB1550440 | DB1550445 | DB1550450 | DB1550455 | DB1550460 | DB1550475 | DB1550485 |
| | | 100 | - | - | DB1550605 | DB1550610 | DB1550615 | DB1550620 | DB1550625 | DB1550630 | DB1550635 | DB1550640 | DB1550645 | DB1550650 | DB1550655 | DB1550665 | DB1550675 |
| | | 120 | - | - | - | - | DB1550820 | - | - | - | DB1550840 | - | - | - | - | DB1550870 | - |
| RAL® 9001 BEIGE BEIGE BEIS | B | 70 | - | DB1552010 | DB1552015 | DB1552020 | DB1552025 | DB1552030 | DB1552035 | DB1552040 | DB1552045 | DB1552050 | DB1552055 | DB1552060 | DB1552065 | DB1552075 | - |
| | | 80 | DB1552200 | DB1552205 | DB1552210 | DB1552215 | DB1552220 | DB1552225 | DB1552230 | DB1552235 | DB1552240 | DB1552245 | DB1552250 | DB1552255 | DB1552260 | DB1552270 | DB1552280 |
| | | 90 | - | DB1552400 | DB1552405 | DB1552410 | DB1552415 | DB1552420 | DB1552425 | DB1552430 | DB1552435 | DB1552440 | DB1552445 | DB1552450 | DB1552455 | DB1552465 | DB1552475 |
| | | 100 | - | - | DB1552605 | DB1552610 | DB1552615 | DB1552620 | DB1552625 | DB1552630 | DB1552635 | DB1552640 | DB1552645 | DB1552650 | DB1552655 | DB1552665 | DB1552675 |
| | | 120 | - | - | - | - | DB1552820 | - | - | - | DB1552840 | - | - | - | - | DB1552870 | - |
| RAL® 7016 ANTRACITE ANTRACITE ANTRACITE | B | 70 | - | DB1553010 | DB1553015 | DB1553020 | DB1553025 | DB1553030 | DB1553035 | DB1553040 | DB1553045 | DB1553050 | DB1553055 | DB1553060 | DB1553065 | DB1553075 | - |
| | | 80 | DB1553200 | DB1553205 | DB1553210 | DB1553215 | DB1553220 | DB1553225 | DB1553230 | DB1553235 | DB1553240 | DB1553245 | DB1553250 | DB1553255 | DB1553260 | DB1553270 | DB1553280 |
| | | 90 | - | DB1553400 | DB1553405 | DB1553410 | DB1553415 | DB1553420 | DB1553425 | DB1553430 | DB1553435 | DB1553440 | DB1553445 | DB1553450 | DB1553455 | DB1553465 | DB1553475 |
| | | 100 | - | - | DB1553605 | DB1553610 | DB1553615 | DB1553620 | DB1553625 | DB1553630 | DB1553635 | DB1553640 | DB1553645 | DB1553650 | DB1553655 | DB1553665 | DB1553675 |
| | | 120 | - | - | - | - | DB1553820 | - | - | - | DB1553840 | - | - | - | - | DB1553870 | - |
| RAL® 9005 BLACK NOIR NEGRO | B | 70 | - | DB1551010 | DB1551015 | DB1551020 | DB1551025 | DB1551030 | DB1551035 | DB1551040 | DB1551045 | DB1551050 | DB1551055 | DB1551060 | DB1551065 | DB1551075 | - |
| | | 80 | DB1551200 | DB1551210 | DB1551215 | DB1551220 | DB1551225 | DB1551230 | DB1551235 | DB1551240 | DB1551245 | DB1551250 | DB1551255 | DB1551260 | DB1551265 | DB1551275 | DB1551285 |
| | | 90 | - | DB1551400 | DB1551405 | DB1551410 | DB1551415 | DB1551420 | DB1551425 | DB1551430 | DB1551435 | DB1551440 | DB1551445 | DB1551450 | DB1551455 | DB1551465 | DB1551475 |
| | | 100 | - | - | DB1551605 | DB1551610 | DB1551615 | DB1551620 | DB1551625 | DB1551630 | DB1551635 | DB1551640 | DB1551645 | DB1551650 | DB1551655 | DB1551665 | DB1551675 |
| | | 120 | - | - | - | - | DB1551820 | - | - | - | DB1551840 | - | - | - | - | DB1551870 | - |
| RAL® 7030 GRAY GRIS GRIS | B | 70 | - | DB1555010 | DB1555015 | DB1555020 | DB1555025 | DB1555030 | DB1555035 | DB1555040 | DB1555045 | DB1555050 | DB1555055 | DB1555060 | DB1555065 | DB1555075 | - |
| | | 80 | DB1555200 | DB1555205 | DB1555210 | DB1555215 | DB1555220 | DB1555225 | DB1555230 | DB1555235 | DB1555240 | DB1555245 | DB1555250 | DB1555255 | DB1555260 | DB1555270 | DB1555280 |
| | | 90 | - | DB1555400 | DB1555405 | DB1555410 | DB1555415 | DB1555420 | DB1555425 | DB1555430 | DB1555435 | DB1555440 | DB1555445 | DB1555450 | DB1555455 | DB1555465 | DB1555475 |
| | | 100 | - | - | DB1555605 | DB1555610 | DB1555615 | DB1555620 | DB1555625 | DB1555630 | DB1555635 | DB1555640 | DB1555645 | DB1555650 | DB1555655 | DB1555665 | DB1555675 |
| | | 120 | - | - | - | - | DB1555820 | - | - | - | DB1555840 | - | - | - | - | DB1555870 | - |

PRICE INCLUDES STAINLESS STEEL GRILL AND VALVE | LE PRIX COMPREND LA GRILLE EN ACIER INOXYDABLE ET LE VIDAGE | EL PRECIO INCLUYE REJILLA EN ACERO INOXIDABLE Y VÁLVULA



HEIGHT
HAUTEUR
ALTURA
55 mm

INFINITY

ACRYLIC SHOWER TRAY
RECEVEUR DE DOUCHE ACRYLIQUE
PLATO DE DUCHA ACRÍLICO

| REF. | MEASURES MESURES MEDIDAS |
|-----------|------------------------------|
| DBI500000 | 70 x 70 cm |
| DBI500010 | 70 x 90 cm |
| DBI500015 | 70 x 100 cm |
| DBI500020 | 70 x 110 cm |
| DBI500025 | 70 x 120 cm |
| DBI500030 | 70 x 130 cm |
| DBI500035 | 70 x 140 cm |
| DBI500040 | 70 x 150 cm |
| DBI500045 | 70 x 160 cm |
| DBI500050 | 70 x 170 cm |
| DBI500055 | 70 x 180 cm |
| DBI500060 | 70 x 190 cm |
| DBI500065 | 70 x 200 cm |
| DBI500100 | 75 x 75 cm |
| DBI500110 | 75 x 90 cm |
| DBI500115 | 75 x 100 cm |
| DBI500120 | 75 x 110 cm |
| DBI500125 | 75 x 120 cm |
| DBI500130 | 75 x 130 cm |
| DBI500135 | 75 x 140 cm |
| DBI500140 | 75 x 150 cm |
| DBI500145 | 75 x 160 cm |
| DBI500150 | 75 x 170 cm |
| DBI500155 | 75 x 180 cm |
| DBI500160 | 75 x 190 cm |
| DBI500165 | 75 x 200 cm |
| DBI500200 | 80 x 80 cm |
| DBI500210 | 80 x 90 cm |
| DBI500215 | 80 x 100 cm |
| DBI500220 | 80 x 110 cm |
| DBI500225 | 80 x 120 cm |
| DBI500230 | 80 x 130 cm |
| DBI500235 | 80 x 140 cm |
| DBI500240 | 80 x 150 cm |
| DBI500245 | 80 x 160 cm |
| DBI500250 | 80 x 170 cm |
| DBI500255 | 80 x 180 cm |
| DBI500260 | 80 x 190 cm |
| DBI500265 | 80 x 200 cm |
| DBI500300 | 90 x 90 cm |
| DBI500310 | 90 x 100 cm |
| DBI500315 | 90 x 110 cm |
| DBI500320 | 90 x 120 cm |
| DBI500325 | 90 x 130 cm |
| DBI500330 | 90 x 140 cm |
| DBI500335 | 90 x 150 cm |
| DBI500340 | 90 x 160 cm |
| DBI500345 | 90 x 170 cm |
| DBI500350 | 90 x 180 cm |
| DBI500355 | 90 x 190 cm |
| DBI500360 | 90 x 200 cm |

SUGGESTION | SUGGESTION | SUGERENCIA

SHOWER VALVE | VIDAGE DE DOUCHE | VÁLVULA DE DUCHA

DRAIN

INNOVATIVE SYSTEM
SISTÈME INNOVANT
SISTEMA INNOVADOR

HIGH DRAINAGE FLOW
DÉBIT DE DRAINAGE ÉLEVÉ
ALTO FLUJO DE DRENAJE

Water flow rate highly above the criteria required by the EN-274 Standard (<24L / min)
Débit supérieure aux critères exigés dans la norme européenne EN-274 (<24L / min)
Velocidad del flujo superior a los criterios exigidos por la normativa europea EN-274 (<24L / min)

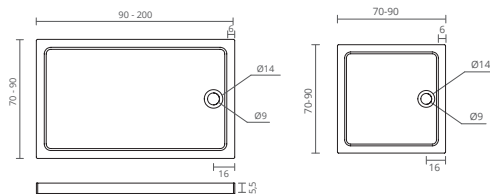

HEIGHT
HAUTEUR
ALTURA
55 mm

TIME

ROUND ACRYLIC SHOWER TRAY
RECEVEUR DE DOUCHE ACRYLIQUE ROND
PLATO DE DUCHA ACRÍLICO CIRCULAR

| REF. | MEASURES MESURES MEDIDAS |
|-----------|------------------------------|
| DBI501000 | 80 x 80 cm |
| DBI501005 | 90 x 90 cm |

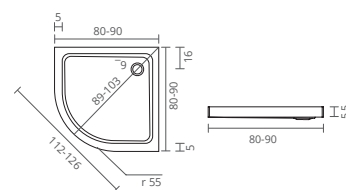

HEIGHT
HAUTEUR
ALTURA **35 mm**



SOFT

ACRYLIC SHOWER TRAY
RECEVEUR DE DOUCHE ACRYLIQUE
PLATO DE DUCHA ACRÍLICO

| REF. | MEASURES MESURES MEDIDAS |
|-----------|------------------------------|
| DBI502000 | 70 x 70 cm |
| DBI502010 | 70 x 90 cm |
| DBI502015 | 70 x 100 cm |
| DBI502020 | 70 x 110 cm |
| DBI502025 | 70 x 120 cm |
| DBI502030 | 70 x 130 cm |
| DBI502035 | 70 x 140 cm |
| DBI502040 | 70 x 150 cm |
| DBI502045 | 70 x 160 cm |
| DBI502050 | 70 x 170 cm |
| DBI502055 | 70 x 180 cm |
| DBI502060 | 70 x 190 cm |
| DBI502065 | 70 x 200 cm |
| DBI502100 | 75 x 75cm |
| DBI502110 | 75 x 90 cm |
| DBI502115 | 75 x 100 cm |
| DBI502120 | 75 x 110 cm |
| DBI502125 | 75 x 120 cm |
| DBI502130 | 75 x 130 cm |
| DBI502135 | 75 x 140 cm |
| DBI502140 | 75 x 150 cm |
| DBI502145 | 75 x 160 cm |
| DBI502150 | 75 x 170 cm |
| DBI502155 | 75 x 180 cm |
| DBI502160 | 75 x 190 cm |
| DBI502165 | 75 x 200 cm |
| DBI502200 | 80 x 80 cm |
| DBI502210 | 80 x 90 cm |
| DBI502215 | 80 x 100 cm |
| DBI502220 | 80 x 110 cm |
| DBI502225 | 80 x 120 cm |
| DBI502230 | 80 x 130 cm |
| DBI502235 | 80 x 140 cm |
| DBI502240 | 80 x 150 cm |
| DBI502245 | 80 x 160 cm |
| DBI502250 | 80 x 170 cm |
| DBI502255 | 80 x 180 cm |
| DBI502260 | 80 x 190 cm |
| DBI502265 | 80 x 200 cm |
| DBI502300 | 90 x 90 cm |
| DBI502310 | 90 x 100 cm |
| DBI502315 | 90 x 110 cm |
| DBI502320 | 90 x 120 cm |
| DBI502325 | 90 x 130 cm |
| DBI502330 | 90 x 140 cm |
| DBI502335 | 90 x 150 cm |
| DBI502340 | 90 x 160 cm |
| DBI502345 | 90 x 170 cm |
| DBI502350 | 90 x 180 cm |
| DBI502355 | 90 x 190 cm |
| DBI502360 | 90 x 200 cm |

SUGGESTION | SUGGESTION | SUGERENCIA

SHOWER VALVE | VIDAGE DE DOUCHE | VÁLVULA DE DUCHA

DRAIN

INNOVATIVE SYSTEM
SISTÈME INNOVANT
SISTEMA INNOVADOR

HIGH DRAINAGE FLOW
DÉBIT DE DRAINAGE ÉLEVÉ
ALTO FLUJO DE DRENAJE

Water flow rate highly above the criteria required by the EN-274 Standard (<24L / min)
Débit supérieure aux critères exigés dans la norme européenne EN-274 (<24L / min)
Velocidad del flujo superior a los criterios exigidos por la normativa europea EN-274 (<24L / min)

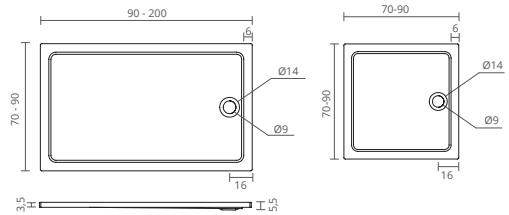

HEIGHT
HAUTEUR
ALTURA **35 mm**

PLANUS

ROUND ACRYLIC SHOWER TRAY
RECEVEUR DE DOUCHE ACRYLIQUE ROND
PLATO DE DUCHA ACRÍLICO CIRCULAR

| REF. | MEASURES MESURES MEDIDAS |
|-----------|------------------------------|
| DBI503000 | 80 x 80 cm |
| DBI503005 | 90 x 90 cm |

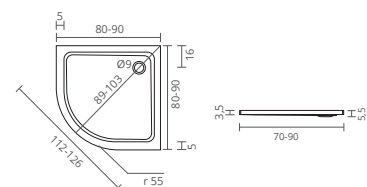





electric towel heaters sèche-serviettes électriques toalleros eléctricos

Choosing an electric towel heater for your bathroom is always a good decision. Thanks to their technical features, these towel heaters are moisture resistant, allowing your towels to heat up and quickly dry, while giving warmth to your bathroom.

Choisir un sèche-serviettes électrique pour votre salle de bains est toujours une bonne décision. Grâce à leurs caractéristiques techniques, ces sèche-serviettes sont ultra résistants à l'humidité, ce qui permet de chauffer des serviettes et de les sécher rapidement, tout en apportant de la chaleur à votre salle de bains.

Elegir un toallero eléctrico para tu baño siempre es una buena decisión. Gracias a sus características técnicas, estos toalleros son ultrarresistentes a la humedad, permitiendo que las toallas se calienten y se sequen rápidamente, mientras aportan calidez a tu baño.

ELECTRICAL TOWEL HEATERS SÈCHE-SERVIETTES ÉLECTRIQUES TOALLEROS ELÉCTRICOS

Our electric towel heaters provide space and organization, allowing you to quickly dry your towels while efficiently heating your bathroom.

Its simple but very resistant lines, structure and efficient design allow them to match any bathroom style. Its resistant supports allow a uniform fixing, ensuring security and stability, while creating a multipurpose space for you to place your towels.

Nos sèche-serviettes électriques vous offrent de l'espace et de l'organisation et vous permettent de sécher rapidement vos serviettes, tout en chauffant efficacement votre salle de bains.

Sa structure simple mais très résistante et son design efficace leur permettent de s'adapter à quelque style de salle de bains.

Ses supports résistants permettent une fixation uniforme et assurent de la sécurité et de la stabilité, tout en créant un espace polyvalent où vous pouvez placer vos serviettes de bains.

Los toalleros eléctricos son elementos que aportan organización y que permiten un secado rápido de las toallas, mientras calientan tu baño de manera eficiente.

Con una estructura sencilla, pero muy resistente, cuentan con un diseño eficiente que permite que se adapten a diferentes estilos y ambientes de baño.

Sus soportes resistentes permiten obtener una fijación uniforme, garantizando seguridad y estabilidad, mientras permiten crear un espacio polivalente para colocar tus toallas de baño.

- Harmonious design
- Towel heating and drying
- Maximum temperature 110°C
- Bathroom heating
- Moisture resistant
- Anti-corrosion steel
- Design harmonieux
- Chauffage et séchage des serviettes
- Température maximale 110°C
- Chauffage de la salle de bains
- Résistant à l'humidité
- Acier anticorrosion
- Diseño armonioso
- Secado y calentamiento de toallas
- Temperatura máxima 110°C
- Calefacción del baño
- Resistente a la humedad
- Acero anticorrosión

Choose the towel heater that suits you best and turn your bathroom into a more pleasant space.

Choisissez parmi nos sèche-serviettes et transformez votre salle de bains en un espace plus agréable.

Elige el tipo de toallero que deseas y convierte tu baño en un espacio más agradable.

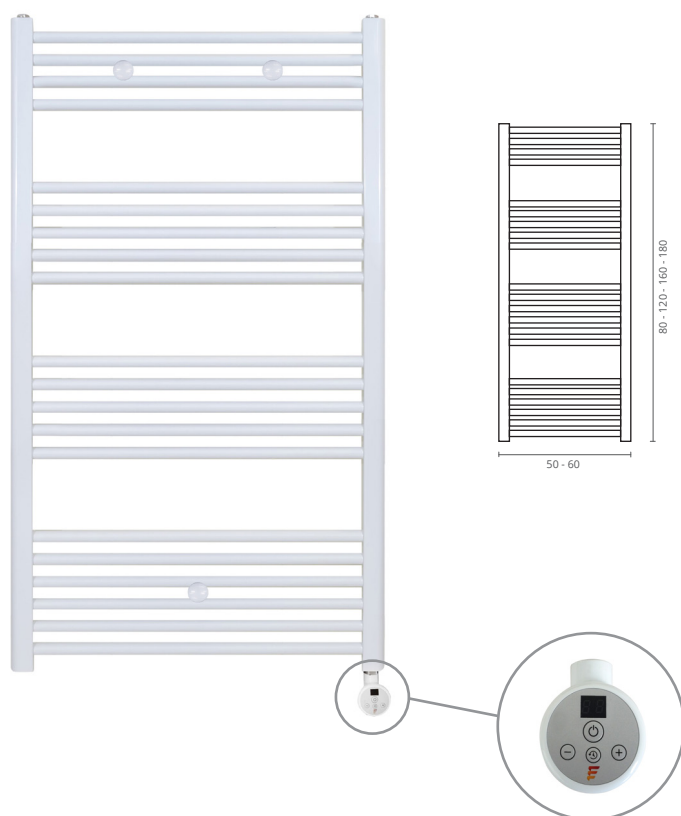

- Thermostatic remote control
- Temperature regulation
- Time regulation (1 to 5 hours)
- Includes fixings
- Includes connection plug
- Ready to install

- Télécommande thermostatique
- Régulation de la température
- Régulation du temps (1 à 5 heures)
- Inclut des fixations
- Inclut une fiche de connexion
- Prêt à installer

- Control termostático
- Regulación de la temperatura
- Regulación del tiempo (1 a 5 horas)
- Incluye fijaciones
- Incluye enchufe de conexión
- Listo para instalar

WHITE ELECTRIC TOWEL HEATER SÈCHE-SERVIETTES ÉLECTRIQUE BLANC TOALLERO ELÉCTRICO BLANCO

| REF. | MEASURES MESURES MEDIDAS | WATTS | N° OF TUBES N° DE TUBES N° DE TUBOS |
|-----------|--------------------------------|-------|---|
| CT1002000 | 50 x 80 cm | 300 | 13 |
| CT1002002 | 60 x 80 cm | 300 | 13 |
| CT1002020 | 50 x 120 cm | 500 | 20 |
| CT1002022 | 60 x 120 cm | 500 | 20 |
| CT1002040 | 50 x 160 cm | 700 | 27 |
| CT1002042 | 60 x 160 cm | 700 | 27 |
| CT1002060 | 50 x 180 cm | 900 | 31 |
| CT1002062 | 60 x 180 cm | 900 | 31 |

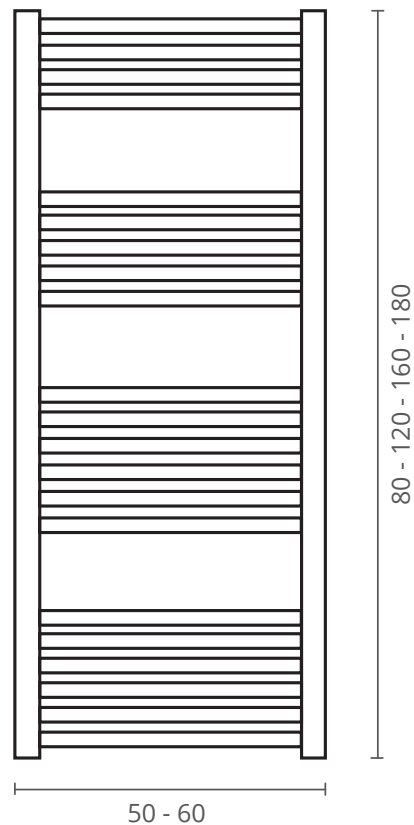
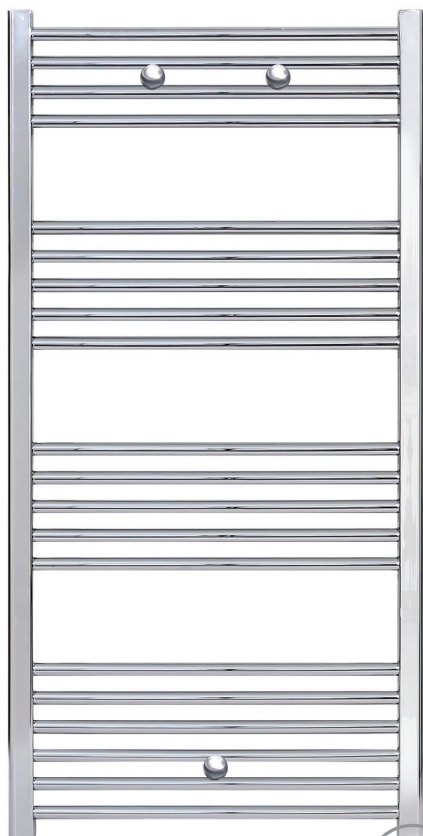

- . Thermostatic remote control
- . Temperature regulation
- . Time regulation (1 to 5 hours)
- . Includes fixings
- . Includes connection plug
- . Ready to install

- . Télécommande thermostatique
- . Régulation de la température
- . Régulation du temps (1 à 5 heures)
- . Inclut des fixations
- . Inclut une fiche de connexion
- . Prêt à installer

- . Control termostático
- . Regulación de la temperatura
- . Regulación del tiempo (1 a 5 horas)
- . Incluye fijaciones
- . Incluye enchufe de conexión
- . Listo para instalar

CHROMED ELECTRIC TOWEL HEATER
SÈCHE-SERVIETTES ÉLECTRIQUE CHROMÉ
TOALLERO ELÉCTRICO CROMADO

| REF. | MEASURES MEDIDAS | WATTS | N° OF TUBES N° DE TUBES N° DE TUBOS |
|------------------|---------------------|-------|---|
| CT1002200 | 50 x 80 cm | 300 | 13 |
| CT1002202 | 60 x 80 cm | 300 | 13 |
| CT1002220 | 50 x 120 cm | 500 | 20 |
| CT1002222 | 60 x 120 cm | 500 | 20 |
| CT1002240 | 50 x 160 cm | 700 | 27 |
| CT1002242 | 60 x 160 cm | 700 | 27 |
| CT1002260 | 50 x 180 cm | 900 | 31 |
| CT1002262 | 60 x 180 cm | 900 | 31 |

CHROMED
 CHROME
 CROMADO

kitchen sinks évier de cuisine fregaderos

Your kitchen deserves a Ctesi sink. Choose between different models and equip your kitchen with elegant and functional sinks. With one or two bowls, with or without a drainer, you have plenty of options to choose from. Match your sink with a high-quality tap for an ultimate kitchen experience.

Votre cuisine mérite un évier Ctesi. Choisissez entre différents modèles et équipez votre cuisine avec des éviers élégants et fonctionnels. Avec un ou deux cuves, avec ou sans égouttoir, vous pouvez choisir entre de nombreuses options. Complétez votre évier avec un excellent robinet de cuisine pour avoir la meilleure expérience.

Tu cocina se merece un fregadero Ctesi. Elige entre diferentes formatos y equipa tu cocina con fregaderos elegantes y funcionales. Con una o dos cubetas, con o sin escurridor, las opciones son variadas. Combina tu fregadero con un excelente grifo para disfrutar de la mejor experiencia en la cocina.



GLAMOUR

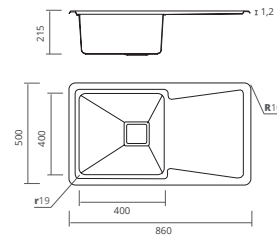

- . Cut-out size: 840x480 mm
- . Includes siphon with basket
- . Depth: 215 mm
- . Finish: polished
- . Cabinet size: 60 cm
- . Thickness: 1,2 mm

- . *Mesure de coupe: 840x480 mm*
- . *Inclut siphon avec panier*
- . *Profondeur: 215 mm*
- . *Finition: polie*
- . *Meuble: 60 cm*
- . *Épaisseur: 1,2 mm*

- . Dimensión de recorte: 840x480 mm
- . Incluye sifón con cestillo
- . Profundidad: 215 mm
- . Acabado: pulido
- . Dimensión del mueble: 60 cm
- . Espesor: 1,2 mm

GLAMOUR

SINGLE BOWL WITH DRAINER CUVE SEULE AVEC ÉGOUTTOIR 1 CUBETA CON ESCURRIDOR

| UN | REF. | MEASURES MESURES MEDIDAS |
|----|-----------|------------------------------|
| 1 | CT3002200 | 860x500 mm |

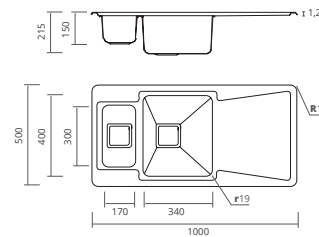
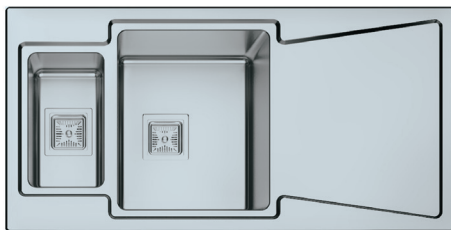

- . Cut-out size: 980x480 mm
- . Includes siphon with basket
- . Depth: 215 mm
- . Finish: polished
- . Cabinet size: 60 cm
- . Thickness: 1,2 mm

- . *Mesure de coupe: 980x480 mm*
- . *Inclut siphon avec panier*
- . *Profondeur: 215 mm*
- . *Finition: polie*
- . *Meuble: 60 cm*
- . *Épaisseur: 1,2 mm*

- . Dimensión de recorte: 980x480 mm
- . Incluye sifón con cestillo
- . Profundidad: 215 mm
- . Acabado: pulido
- . Dimensión del mueble: 60 cm
- . Espesor: 1,2 mm

GLAMOUR

1 AND A HALF BOWL WITH DRAINER 1 CUVE ET DEMI AVEC ÉGOUTTOIR 1 CUBETA Y MEDIA CON ESCURRIDOR

| UN | REF. | MEASURES MESURES MEDIDAS |
|----|-----------|------------------------------|
| 1 | CT3002210 | 1000x500 mm |

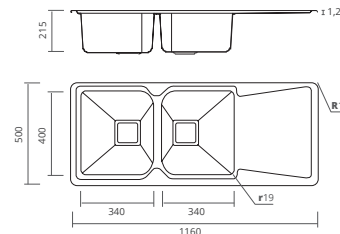
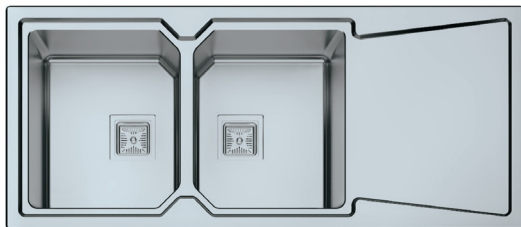

- . Cut-out size: 1140x480 mm
- . Includes siphon with basket
- . Depth: 215 mm
- . Finish: polished
- . Cabinet size: 80 cm
- . Thickness: 1,2 mm

- . *Mesure de coupe: 1140x480 mm*
- . *Inclut siphon avec panier*
- . *Profondeur: 215 mm*
- . *Finition: polie*
- . *Meuble: 80 cm*
- . *Épaisseur: 1,2 mm*

- . Dimensión de recorte: 1140x480 mm
- . Incluye sifón con cestillo
- . Profundidad: 215 mm
- . Acabado: pulido
- . Dimensión del mueble: 80 cm
- . Espesor: 1,2 mm

GLAMOUR

2 BOWLS WITH DRAINER 2 CUVES AVEC ÉGOUTTOIR 2 CUBETAS CON ESCURRIDOR

| UN | REF. | MEASURES MESURES MEDIDAS |
|----|-----------|------------------------------|
| 1 | CT3002220 | 1160x500 mm |



R EXTERNAL RADIUS
RAYON EXTÉRIEUR
RADIO EXTERIOR

r BOWL RADIUS
RAYON DE LA CUVE
RADIO DE LA CUBETA

CUBO



- . Cut-out size: 840x480 mm
- . Includes siphon with basket
- . Depth: 205 mm
- . Finish: polished
- . Cabinet size: 60 cm
- . Thickness: 0,8 mm
- . *Mesure de coupe: 840x480 mm*
- . *Inclut siphon avec panier*
- . *Profondeur: 205 mm*
- . *Finition: polie*
- . *Meuble: 60 cm*
- . *Épaisseur: 0,8 mm*
- . Dimensión de recorte: 840x480 mm
- . Incluye sifón con cestillo
- . Profundidad: 205 mm
- . Acabado: pulido
- . Dimensión del mueble: 60 cm
- . Espesor: 0,8 mm

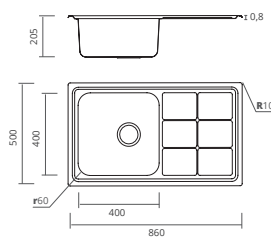

CUBO

SINGLE BOWL WITH DRAINER
CUVE SEULE AVEC ÉGOUTTOIR
1 CUBETA CON ESCURRIDOR

| UN | REF. | MEASURES MESURES MEDIDAS |
|----|-----------|------------------------------|
| 1 | CT3002000 | 860x500 mm |



- . Cut-out size: 950x480 mm
- . Includes siphon with basket
- . Depth: 200 mm
- . Finish: polished
- . Cabinet size: 60 cm
- . Thickness: 0,8 mm
- . *Mesure de coupe: 950x480 mm*
- . *Inclut siphon avec panier*
- . *Profondeur: 200 mm*
- . *Finition: polie*
- . *Meuble: 60 cm*
- . *Épaisseur: 0,8 mm*
- . Dimensión de recorte: 950x480 mm
- . Incluye sifón con cestillo
- . Profundidad: 200 mm
- . Acabado: pulido
- . Dimensión del mueble: 60 cm
- . Espesor: 0,8 mm

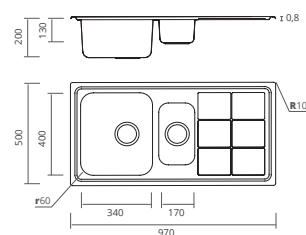

CUBO

1 AND A HALF BOWL WITH DRAINER
1 CUVE ET DEMI AVEC ÉGOUTTOIR
1 CUBETA Y MEDIA CON ESCURRIDOR

| UN | REF. | MEASURES MESURES MEDIDAS |
|----|-----------|------------------------------|
| 1 | CT3002010 | 970x500 mm |



- . Cut-out size: 1140x480 mm
- . Includes siphon with basket
- . Depth: 200 mm
- . Finish: polished
- . Cabinet size: 80 cm
- . Thickness: 0,8 mm
- . *Mesure de coupe: 1140x480 mm*
- . *Inclut siphon avec panier*
- . *Profondeur: 200 mm*
- . *Finition: polie*
- . *Meuble: 80 cm*
- . *Épaisseur: 0,8 mm*
- . Dimensión de recorte: 1140x480 mm
- . Incluye sifón con cestillo
- . Profundidad: 200 mm
- . Acabado: pulido
- . Dimensión del mueble: 80 cm
- . Espesor: 0,8 mm

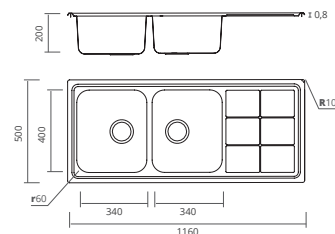

CUBO

2 BOWLS WITH DRAINER
2 CUVES AVEC ÉGOUTTOIR
2 CUBETAS CON ESCURRIDOR

| UN | REF. | MEASURES MESURES MEDIDAS |
|----|-----------|------------------------------|
| 1 | CT3002020 | 1160x500 mm |



R EXTERNAL RADIUS
 RAYON EXTÉRIEUR
 RADIO EXTERIOR

r BOWL RADIUS
 RAYON DE LA CUVE
 RADIO DE LA CUBETA

MINIMAL

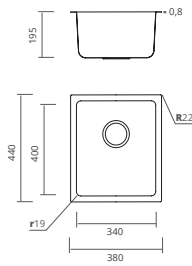

- . Cut-out size: 345x405 mm
- . Includes siphon with basket
- . Depth: 195 mm
- . Finish: brushed
- . Cabinet size: 40 cm
- . Thickness: 0,8 mm
- . *Mesure de coupe: 345x405 mm*
- . *Inclut siphon avec panier*
- . *Profondeur: 195 mm*
- . *Finition: brossé*
- . *Meuble: 40 cm*
- . *Épaisseur: 0,8 mm*
- . Dimension de recorte: 345x405 mm
- . Incluye sifón con cestillo
- . Profundidad: 195 mm
- . Acabado: cepillado
- . Dimensión del mueble: 40 cm
- . Espesor: 0,8 mm

MINIMAL

SINGLE BOWL CUVE SEULE 1 CUBETA

| UN | REF. | MEASURES MESURES MEDIDAS |
|----|-----------|--------------------------------|
| 1 | CT3000280 | 380x440 mm |

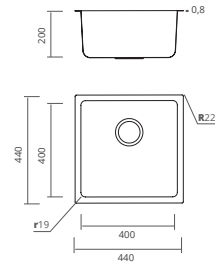

- . Cut-out size: 405x405 mm
- . Includes siphon with basket
- . Depth: 200 mm
- . Finish: brushed
- . Cabinet size: 60 cm
- . Thickness: 0,8 mm
- . *Mesure de coupe: 405x405 mm*
- . *Inclut siphon avec panier*
- . *Profondeur: 200 mm*
- . *Finition: brossé*
- . *Meuble: 60 cm*
- . *Épaisseur: 0,8 mm*
- . Dimension de recorte: 405x405 mm
- . Incluye sifón con cestillo
- . Profundidad: 200 mm
- . Acabado: cepillado
- . Dimensión del mueble: 60 cm
- . Espesor: 0,8 mm

MINIMAL

SINGLE BOWL CUVE SEULE 1 CUBETA

| UN | REF. | MEASURES MESURES MEDIDAS |
|----|-----------|--------------------------------|
| 1 | CT3000270 | 440x440 mm |

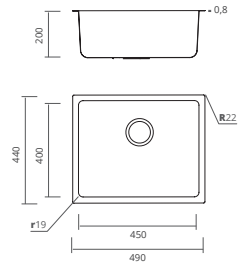

- . Cut-out size: 455x405 mm
- . Includes siphon with basket
- . Depth: 200 mm
- . Finish: brushed
- . Cabinet size: 60 cm
- . Thickness: 0,8 mm
- . *Mesure de coupe: 455x405 mm*
- . *Inclut siphon avec panier*
- . *Profondeur: 200 mm*
- . *Finition: brossé*
- . *Meuble: 60 cm*
- . *Épaisseur: 0,8 mm*
- . Dimension de recorte: 455x405 mm
- . Incluye sifón con cestillo
- . Profundidad: 200 mm
- . Acabado: cepillado
- . Dimensión del mueble: 60 cm
- . Espesor: 0,8 mm

MINIMAL

SINGLE BOWL CUVE SEULE 1 CUBETA

| UN | REF. | MEASURES MESURES MEDIDAS |
|----|-----------|--------------------------------|
| 1 | CT3000250 | 490x440 mm |

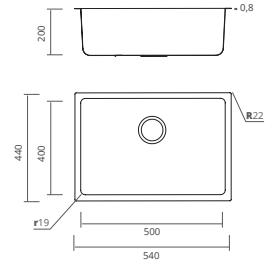

- . Cut-out size: 505x405 mm
- . Includes siphon with basket
- . Depth: 200 mm
- . Finish: brushed
- . Cabinet size: 60 cm
- . Thickness: 0,8 mm
- . *Mesure de coupe: 505x405 mm*
- . *Inclut siphon avec panier*
- . *Profondeur: 200 mm*
- . *Finition: brossé*
- . *Meuble: 60 cm*
- . *Épaisseur: 0,8 mm*
- . Dimension de recorte: 505x405 mm
- . Incluye sifón con cestillo
- . Profundidad: 200 mm
- . Acabado: cepillado
- . Dimensión del mueble: 60 cm
- . Espesor: 0,8 mm

MINIMAL

SINGLE BOWL CUVE SEULE 1 CUBETA

| UN | REF. | MEASURES MESURES MEDIDAS |
|----|-----------|--------------------------------|
| 1 | CT3000260 | 540x440 mm |



R EXTERNAL RADIUS
RAYON EXTÉRIEUR
RADIO EXTERIOR

r BOWL RADIUS
RAYON DE LA CUVE
RADIO DE LA CUBETA

GLOBE

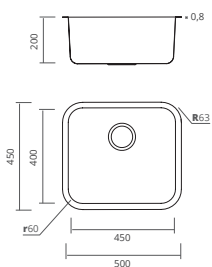

Cut-out size: 455x405 mm
Includes siphon with basket
Depth: 200 mm
Finish: polished
Cabinet size: 60 cm
Thickness: 0,8 mm

Mesure de coupe: 455x405 mm
Inclut siphon avec panier
Profondeur: 200 mm
Finition: polie
Meuble: 60 cm
Épaisseur: 0,8 mm

Dimensión de recorte: 455x405 mm
Incluye sifón con cestillo
Profundidad: 200 mm
Acabado: pulido
Dimensión del mueble: 60 cm
Espesor: 0,8 mm

GLOBE

SINGLE BOWL
CUVE SEULE
1 CUBETA

| UN | REF. | MEASURES MESURES MEDIDAS |
|----|-----------|--------------------------------|
| 1 | CT3000330 | 500x450 mm |

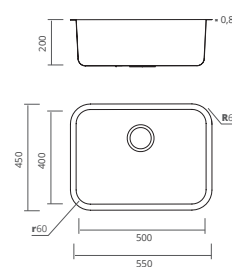

Cut-out size: 505x405 mm
Includes siphon with basket
Depth: 200 mm
Finish: polished
Cabinet size: 60 cm
Thickness: 0,8 mm

Mesure de coupe: 505x405 mm
Inclut siphon avec panier
Profondeur: 200 mm
Finition: polie
Meuble: 60 cm
Épaisseur: 0,8 mm

Dimensión de recorte: 505x405 mm
Incluye sifón con cestillo
Profundidad: 200 mm
Acabado: pulido
Dimensión del mueble: 60 cm
Espesor: 0,8 mm

GLOBE

SINGLE BOWL
CUVE SEULE
1 CUBETA

| UN | REF. | MEASURES MESURES MEDIDAS |
|----|-----------|--------------------------------|
| 1 | CT3000320 | 550x450 mm |

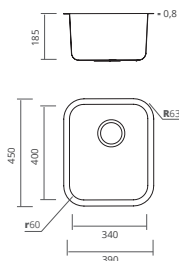

Cut-out size: 345x405 mm
Includes siphon with basket
Depth: 185 mm
Finish: polished
Cabinet size: 40 cm
Thickness: 0,8 mm

Mesure de coupe: 345x405 mm
Inclut siphon avec panier
Profondeur: 185 mm
Finition: polie
Meuble: 40 cm
Épaisseur: 0,8 mm

Dimensión de recorte: 345x405 mm
Incluye sifón con cestillo
Profundidad: 185 mm
Acabado: pulido
Dimensión del mueble: 40 cm
Espesor: 0,8 mm

GLOBE

SINGLE BOWL
CUVE SEULE
1 CUBETA

| UN | REF. | MEASURES MESURES MEDIDAS |
|----|-----------|--------------------------------|
| 1 | CT3000300 | 390x450 mm |

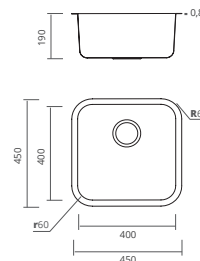

Cut-out size: 405x405 mm
Includes siphon with basket
Depth: 190 mm
Finish: polished
Cabinet size: 60 cm
Thickness: 0,8 mm

Mesure de coupe: 405x405 mm
Inclut siphon avec panier
Profondeur: 190 mm
Finition: polie
Meuble: 60 cm
Épaisseur: 0,8 mm

Dimensión de recorte: 405x405 mm
Incluye sifón con cestillo
Profundidad: 190 mm
Acabado: pulido
Dimensión del mueble: 60 cm
Espesor: 0,8 mm

GLOBE

SINGLE BOWL
CUVE SEULE
1 CUBETA

| UN | REF. | MEASURES MESURES MEDIDAS |
|----|-----------|--------------------------------|
| 1 | CT3000310 | 450x450 mm |



R EXTERNAL RADIUS
RAYON EXTÉRIEUR
RADIO EXTERIOR

r BOWL RADIUS
RAYON DE LA CUVE
RADIO DE LA CUBETA

SKILL

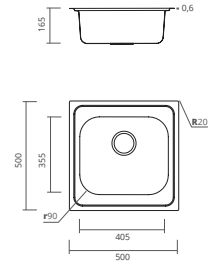
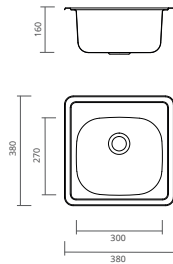

- . Cut-out size: 360x360 mm
- . Includes siphon with basket
- . Depth: 160 mm
- . Finish: polished
- . Cabinet size: 45 cm
- . Thickness: 0,6 mm
- . *Mesure de coupe: 360x360 mm*
- . *Inclut siphon avec panier*
- . *Profondeur: 160 mm*
- . *Finition: polie*
- . *Meuble: 45 cm*
- . *Épaisseur: 0,6 mm*

- . Dimensión de recorte: 360x360 mm
- . Incluye sifón con cestillo
- . Profundidad: 160 mm
- . Acabado: pulido
- . Dimensión del mueble: 45 cm
- . Espesor: 0,6 mm

SKILL

SINGLE BOWL CUVE SEULE 1 CUBETA

| UN | REF. | MEASURES MESURES MEDIDAS |
|----|-----------|--------------------------------|
| 1 | CT3000000 | 380x380 mm |



- . Cut-out size: 480x480 mm
- . Includes siphon with basket
- . Depth: 165 mm
- . Finish: polished
- . Cabinet size: 60 cm
- . Thickness: 0,6 mm
- . *Mesure de coupe: 480x480 mm*
- . *Inclut siphon avec panier*
- . *Profondeur: 165 mm*
- . *Finition: polie*
- . *Meuble: 60 cm*
- . *Épaisseur: 0,6 mm*

- . Dimensión de recorte: 480x480 mm
- . Incluye sifón con cestillo
- . Profundidad: 165 mm
- . Acabado: pulido
- . Dimensión del mueble: 60 cm
- . Espesor: 0,6 mm

SKILL

SINGLE BOWL CUVE SEULE 1 CUBETA

| UN | REF. | MEASURES MESURES MEDIDAS |
|----|-----------|--------------------------------|
| 1 | CT3000010 | 500x500 mm |



R EXTERNAL RADIUS
RAYON EXTÉRIEUR
RADIO EXTERIOR

r BOWL RADIUS
RAYON DE LA CUVE
RADIO DE LA CUBETA

SKILL

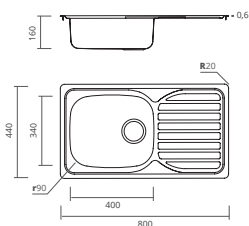

. Cut-out size: 780x420 mm
 . Includes siphon with basket
 . Depth: 160 mm
 . Finish: polished
 . Cabinet size: 60 cm
 . Thickness: 0,6 mm

. *Mesure de coupe: 780x420 mm*
 . *Inclut siphon avec panier*
 . *Profondeur: 160 mm*
 . *Finition: polie*
 . *Meuble: 60 cm*
 . *Épaisseur: 0,6 mm*

. Dimensión de recorte: 780x420 mm
 . Incluye sifón con cestillo
 . Profundidad: 160 mm
 . Acabado: pulido
 . Dimensión del mueble: 60 cm
 . Espesor: 0,6 mm

SKILL

SINGLE BOWL WITH DRAINER
CUVE SEULE AVEC ÉGOUTTOIR
1 CUBETA CON ESCURRIDOR

| UN | REF. | MEASURES MESURES MEDIDAS |
|----|-----------|--------------------------------|
| 1 | CT3001210 | 800x440 mm |

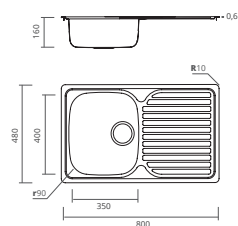

. Cut-out size: 780x460 mm
 . Includes siphon with basket
 . Depth: 160 mm
 . Finish: polished
 . Cabinet size: 40 cm
 . Thickness: 0,6 mm

. *Mesure de coupe: 780x460 mm*
 . *Inclut siphon avec panier*
 . *Profondeur: 160 mm*
 . *Finition: polie*
 . *Meuble: 40 cm*
 . *Épaisseur: 0,6 mm*

. Dimensión de recorte: 780x460 mm
 . Incluye sifón con cestillo
 . Profundidad: 160 mm
 . Acabado: pulido
 . Dimensión del mueble: 40 cm
 . Espesor: 0,6 mm

SKILL

SINGLE BOWL WITH DRAINER
CUVE SEULE AVEC ÉGOUTTOIR
1 CUBETA CON ESCURRIDOR

| UN | REF. | MEASURES MESURES MEDIDAS |
|----|-----------|--------------------------------|
| 1 | CT3001200 | 800x480 mm |

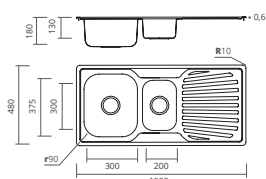

. Cut-out size: 980x460 mm
 . Includes siphon with basket
 . Depth: 180 mm
 . Finish: polished
 . Cabinet size: 60 cm
 . Thickness: 0,6 mm

. *Mesure de coupe: 980x460 mm*
 . *Inclut siphon avec panier*
 . *Profondeur: 180 mm*
 . *Finition: polie*
 . *Meuble: 60 cm*
 . *Épaisseur: 0,6 mm*

. Dimensión de recorte: 980x460 mm
 . Incluye sifón con cestillo
 . Profundidad: 180 mm
 . Acabado: pulido
 . Dimensión del mueble: 60 cm
 . Espesor: 0,6 mm

SKILL

1 AND A HALF BOWL WITH DRAINER
1 CUVE ET DEMI AVEC ÉGOUTTOIR
1 CUBETA Y MEDIA CON ESCURRIDOR

| UN | REF. | MEASURES MESURES MEDIDAS |
|----|-----------|--------------------------------|
| 1 | CT3001500 | 1000x480 mm |

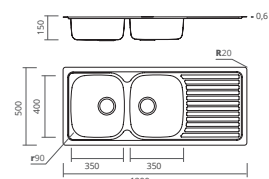

. Cut-out size: 1180x480 mm
 . Includes siphon with basket
 . Depth: 150 mm
 . Finish: polished
 . Cabinet size: 80 cm
 . Thickness: 0,6 mm

. *Mesure de coupe: 1180x480 mm*
 . *Inclut siphon avec panier*
 . *Profondeur: 150 mm*
 . *Finition: polie*
 . *Meuble: 80 cm*
 . *Épaisseur: 0,6 mm*

. Dimensión de recorte: 1180x480 mm
 . Incluye sifón con cestillo
 . Profundidad: 150 mm
 . Acabado: pulido
 . Dimensión del mueble: 80 cm
 . Espesor: 0,6 mm

SKILL

2 BOWLS WITH DRAINER
2 CUVES AVEC ÉGOUTTOIR
2 CUBETAS CON ESCURRIDOR

| UN | REF. | MEASURES MESURES MEDIDAS |
|----|-----------|--------------------------------|
| 1 | CT3001600 | 1200x500 mm |

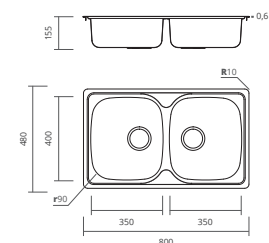

. Cut-out size: 780x460 mm
 . Includes siphon with basket
 . Depth: 155 mm
 . Finish: polished
 . Cabinet size: 80 cm
 . Thickness: 0,6 mm

. *Mesure de coupe: 780x460 mm*
 . *Inclut siphon avec panier*
 . *Profondeur: 155 mm*
 . *Finition: polie*
 . *Meuble: 80 cm*
 . *Épaisseur: 0,6 mm*

. Dimensión de recorte: 780x460 mm
 . Incluye sifón con cestillo
 . Profundidad: 155 mm
 . Acabado: pulido
 . Dimensión del mueble: 80 cm
 . Espesor: 0,6 mm

SKILL

2 BOWLS
2 CUVES
2 CUBETAS

| UN | REF. | MEASURES MESURES MEDIDAS |
|----|-----------|--------------------------------|
| 1 | CT3001410 | 800x480 mm |



R EXTERNAL RADIUS
 RAYON EXTÉRIEUR
 RADIO EXTERIOR

r BOWL RADIUS
 RAYON DE LA CUVE
 RADIO DE LA CUBETA

BALL

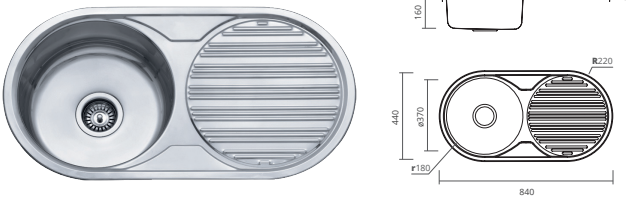

- . Cut-out size: 820x420 mm
- . Includes siphon with basket
- . Depth: 160 mm
- . Finish: polished
- . Cabinet size: 40 cm
- . Thickness: 0,6 mm
- . *Mesure de coupe: 820x420 mm*
- . *Inclut siphon avec panier*
- . *Profondeur: 160 mm*
- . *Finition: polie*
- . *Meuble: 40 cm*
- . *Épaisseur: 0,6 mm*
- . *Dimensión de recorte: 820x420 mm*
- . *Incluye sifón con cestillo*
- . *Profundidad: 160 mm*
- . *Acabado: pulido*
- . *Dimensión del mueble: 40 cm*
- . *Espesor: 0,6 mm*

BALL SINGLE BOWL WITH DRAINER CUVE SEULE AVEC ÉGOUTTOIR 1 CUBETA CON ESCURRIDOR

| UN | REF. | MEASURES MESURES MEDIDAS |
|----|-----------|--------------------------------|
| 1 | CT3001000 | 840x440 mm |

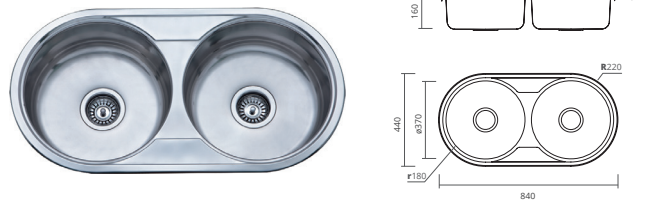

- . Cut-out size: 820x420 mm
- . Includes siphon with basket
- . Depth: 160 mm
- . Finish: polished
- . Cabinet size: 80 cm
- . Thickness: 0,6 mm
- . *Mesure de coupe: 820x420 mm*
- . *Inclut siphon avec panier*
- . *Profondeur: 160 mm*
- . *Finition: polie*
- . *Meuble: 80 cm*
- . *Épaisseur: 0,6 mm*
- . *Dimensión de recorte: 820x420 mm*
- . *Incluye sifón con cestillo*
- . *Profundidad: 160 mm*
- . *Acabado: pulido*
- . *Dimensión del mueble: 80 cm*
- . *Espesor: 0,6 mm*

BALL 2 BOWLS 2 CUVES 2 CUBETAS

| UN | REF. | MEASURES MESURES MEDIDAS |
|----|-----------|--------------------------------|
| 1 | CT3001100 | 840x440 mm |

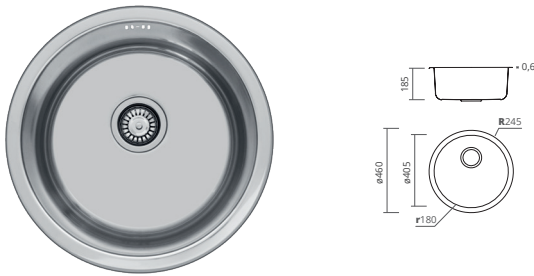

- . Cut-out size: ø440 mm
- . Includes siphon with basket
- . Depth: 185 mm
- . Finish: polished
- . Cabinet size: 60 cm
- . Thickness: 0,6 mm
- . *Mesure de coupe: ø440 mm*
- . *Inclut siphon avec panier*
- . *Profondeur: 185 mm*
- . *Finition: polie*
- . *Meuble: 60 cm*
- . *Épaisseur: 0,6 mm*
- . *Dimensión de recorte: ø440 mm*
- . *Incluye sifón con cestillo*
- . *Profundidad: 185 mm*
- . *Acabado: pulido*
- . *Dimensión del mueble: 60 cm*
- . *Espesor: 0,6 mm*

BALL SINGLE BOWL CUVE SEULE 1 CUBETA

| UN | REF. | MEASURES MESURES MEDIDAS |
|----|-----------|--------------------------------|
| 1 | CT3000110 | Ø460 mm |



- . Cut-out size: ø470 mm
- . Includes siphon with basket
- . Depth: 185 mm
- . Finish: polished
- . Cabinet size: 40 cm
- . Thickness: 0,6 mm
- . *Mesure de coupe: ø470 mm*
- . *Inclut siphon avec panier*
- . *Profondeur: 185 mm*
- . *Finition: polie*
- . *Meuble: 40 cm*
- . *Épaisseur: 0,6 mm*
- . *Dimensión de recorte: ø470 mm*
- . *Incluye sifón con cestillo*
- . *Profundidad: 185 mm*
- . *Acabado: pulido*
- . *Dimensión del mueble: 40 cm*
- . *Espesor: 0,6 mm*

BALL SINGLE BOWL CUVE SEULE 1 CUBETA

| UN | REF. | MEASURES MESURES MEDIDAS |
|----|-----------|--------------------------------|
| 1 | CT3000100 | Ø490 mm |



